



# POWER CORD SET

## PVC / HALOGEN-FREE (HF) CABLE

電源線組 PVC / (HF)無鹵線

**PVC** [www.wellshin.com.tw](http://www.wellshin.com.tw)  
**POWER CORD SET**

Copyright © 2014 by Well Shin Technology Co., Ltd. All rights reserved. None of the information provided here may be used, duplicated, reproduced, either partially or completely, without prior permission of Well Shin.

本公司之目錄享有法律著作權，未經授權不得摘編、拷貝、使用。

Information provided here may consist of uncertainty, Well Shin reserves the right to revise or explain all the time.

目錄中資料可能因疏失而存在錯誤，本公司保留隨時修正或解釋的權利。

## 電源線組標準品P/N編碼原則

### STANDARD POWER CORD SET PART NUMBER ENCODING PRINCIPLE

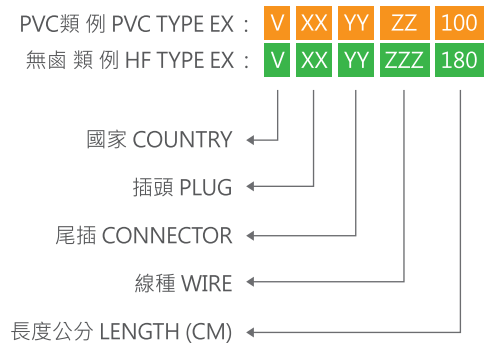

其他規格、顏色、長度、請洽業務人員

For other spec、color、length、please consult our sales members.



## PVC POWER CORD SET

V. 美國 / 加拿大 AMERICA / CANADA .....	9
R. 阿根廷 ARGENTINA .....	12
A. 澳大利亞 AUSTRALIA .....	13
B. 巴西 BRAZIL .....	14
C. 中國 CHINA .....	15
D. 丹麥 DENMARK .....	16
G. 歐洲 EUROPE .....	17
I. 印度 INDIA .....	20
L. 以色列 ISRAEL .....	21
X. 義大利 ITALY .....	22
J. 日本 JAPAN .....	23
K. 韓國 KOREA .....	24
S. 南非 SOUTH AFRICA .....	25
Z. 瑞士 SWITZERLAND .....	26
T. 台灣 TAIWAN .....	27
U. 英國 UNITED KINGDOM .....	28

## HF POWER CORD SET

V. 美國 / 加拿大 AMERICA / CANADA .....	33
R. 阿根廷 ARGENTINA .....	34
A. 澳大利亞 AUSTRALIA .....	35
B. 巴西 BRAZIL .....	36
D. 丹麥 DENMARK .....	37
G. 歐洲 EUROPE .....	37
I. 印度 INDIA .....	39
L. 以色列 ISRAEL .....	40
X. 義大利 ITALY .....	41
J. 日本 JAPAN .....	42
K. 韓國 KOREA .....	43
S. 南非 SOUTH AFRICA .....	44
Z. 瑞士 SWITZERLAND .....	45
T. 台灣 TAIWAN .....	46
U. 英國 UNITED KINGDOM .....	47

# 插頭編碼原則

## PLUG ENCODING PRINCIPLE

國家 COUNTRY	插頭 PLUG	模貝與安規狀況請洽業務人員 For tooling & safety Status, please contact sales members	編號 CODE
日本 / 台灣 TAIWAN / JAPAN	WS-001-17 ( 3 PIN ) ( 5-15P )	<BSMI><PSE><UL/CUL>	01
美國 / 加拿大 / 墨西哥 USA / CANADA / MEXICO	WS-004X ( 2 PIN ) ( 1-15P )	<UL/CUL>	05
中國 CHINA	WS-004B-7 ( 2 PIN ) ( 1-15P )	<CCC>	03
	WS-015D-14 ( 3 PIN / ANGLED )		32
台灣 TAIWAN	WS-005C-8 ( 2 PIN )	<BSMI>	06
日本 JAPAN	WS-005C-8 ( 2 PIN )	<PSE>	06
	WS-005B ( 2 PIN + GROUND )		74
歐洲 EUROPE	WS-006-2 ( 2 PIN )	<EUROPE>	07
	WS-006-3 EMI ( 2 PIN )		33
歐洲 / 韓國 EUROPE / KOREA	WS-010 A-1 ( 3PIN )	<EUROPE><KTC>	13
巴西 BRAZIL	WS-006G ( 2 PIN )	<INMETRO>	54
丹麥 DENMARK	WS-008A-1 ( 3 PIN )	<DEMKO>	61
澳大利亞 AUSTRALIA	WS-009-2 ( 2 PIN )	<SAA>	10
	WS-015-1 ( 3 PIN/ STRAIGHT )		17
阿根廷 ARGENTINA	WS-009F-1 ( 2 PIN )	<IRAM>	11
	WS-015F-1 ( 3 PIN )		02

# 插頭編碼原則

## PLUG ENCODING PRINCIPLE

國家 COUNTRY	插頭 PLUG	模具與安規狀況請洽業務人員 For tooling & safety Status, please contact sales members	編號 CODE
英國 / 新加坡 香港 / 馬來西亞 UK / SINGAPORE HONG KONG MALAYSIA	WS-012E-1 ( 3 PIN )	<BSI>	12
	WS-012E ( 3 PIN )	<BSI> <PSB>	14
義大利 ITALY	WS-013-1 ( 3 PIN )	<IMQ>	15
瑞士 SWITZERLAND	WS-014-1 ( 3 PIN )	<SEV>	16
	WS-014A ( 2 PIN )		79
南非 / 印度 SOUTH AFRICA INDIA	WS-016-A ( 3 PIN )	<SABS> <BIS>	18
	WS-018-A ( 3 PIN/ STRAIGHT)		19
	WS-018-B ( 3 PIN/ ANGLED)		20
	WS-006F-1 ( 2 PIN )		21
以色列 ISRAEL	WS-020-A ( 2 PIN/ STRAIGHT )	<SII>	23
	WS-020-B ( 3PIN/ ANGLED)		34
巴西 BRAZIL	WS-311 ( 3PIN/ ANGLED)	<INMETRO>	55

### IEC 60320-1 & 60320-2 INTERNATIONAL STANDARD

國家 COUNTRY	插頭 PLUG	模具與安規狀況請洽業務人員 For tooling & safety Status, please contact sales members	編號 CODE
SHEET A ( 2.5A )	WS-134-1 ( 3 PIN )	<UL,VDE>	27
SHEET C ( 2.5A )	WS-079-3 ( 2 PIN )		28
SHEET E ( 10A )	WS-003-4 ( 3 PIN )	<UL,VDE,BSI>	25
SHEET I ( 16A )	WS-003D-4 ( 3 PIN)	<UL,VDE>	29

# 尾部連接器編碼原則

## END CONNECTOR ENCODING PRINCIPLE

尾部連接器 END CONNECTOR	編號 CODE
WS-027-5 ( 2 PIN / C7)	01
WS-027-8 ( 2 PIN / C7)	02
WS-027-6 ( 2 PIN / C7)	03
WS-002A-3 (STRAIGHT / C13)	04
WS-002A-R4 (RIGHT ANGLE / C13)	05
WS-083-A ( 3 PIN / C5)	06
WS-083-B ( EASY PULL ) (3 PIN / C5)	07
WS-027-P ( EASY PULL ) ( 2 PIN / C7)	08
WS-002A-4 ( 鎖固 / LOCK IN ) UL (C13)	09
WS-002A-4A ( 鎖固 / LOCK IN / LARGER CABLE )	10
WS-002E-3 ( 2 PIN / C17)	11
WS-002F-0 ( 3 PIN / C19)	12
WS-002F-1B 16A / 250V 地線上右彎 ( 3 PIN / C19) GROUND WIRE ON THE TOP, RIGHT ANGLE	13
WS-002F-2B 16A / 250V 地線上左彎 ( 3 PIN / C19) GROUND WIRE ON THE TOP, LEFT ANGLE	14
WS-002F-2C 16A / 250V 地線上左彎鎖固 ( 3 PIN / C19) GROUND WIRE ON THE TOP, LEFT ANGLE / LOCK IN TYPE	15
WS-002F-11 16A / 250V 直式鎖固 ( 3 PIN / C19) STRAIGHT / LOCK IN TYPE	16
WS-026-8 (1-15R / 2PIN) EASY PULL	17
WS-079-3 ( 2 PIN / SHEET C )	18
WS-022-9 LOCK ( 5-15R / 3 PIN) LOCK IN TYPE	19

# PVC 線材編碼原則

## PVC CABLE ENCODING PRINCIPLE

國別 COUNTRY	線材 CABLE	編號 CODE
美國 / 加拿大 USA / CANADA	SPT-2 18AWG 2C 60C	01
	SPT-2 18AWG 2C 105C	02
	SPT-2 18AWG 3C 60C	03
	SPT-2 18AWG 3C 105C	04
	NISPT-2 18AWG 2C 60C	05
	NISPT-2 18AWG 2C 105C	06
	SVT 18AWG 2C 60C	07
	SVT 18AWG 2C 105C	08
	SVT 18AWG 3C 60C	09
	SVT 18AWG 3C 105C	10
	SJT 18AWG 3C 60C	11
	SJT 18AWG 3C 105C	12
	SJT 16AWG 3C 60C	13
	SJT 16AWG 3C 105C	14
	SJT 14AWG 3C 60C	15
	SJT 14AWG 3C 105C	16
	SVT 14AWG 3C + H05VV-F 3 X 2.0mm <sup>2</sup>	17
	SJT 17AWG 3C/105C + H05VV-F 3G 1.0mm <sup>2</sup> , UNIVERSAL	18
	SJT 15AWG 3C/105C + H05VV-F 3G 1.5mm <sup>2</sup> , UNIVERSAL	19

# PVC 線材編碼原則







## PVC CABLE ENCODING PRINCIPLE

國別 COUNTRY	線材 CABLE	編號 CODE
歐洲 / 阿根廷 / 韓國 / 巴西 / 英國 / 澳洲 EUROPEAN / ARGENTINA / KOREA / BRAZIL / UK / AUSTRALIA	H03VVH2-F 2X0.75mm <sup>2</sup> , APPROVAL: KC, UL BR, VDE, FI, D, N, S, +S, IEMMEQU, SAA (WSK-WIRE-01)	31
	H05VVH2-F 2X 0.75mm <sup>2</sup> , APPROVAL:KC, UL BR, VDE, FI, D, N, S, +S, IEMMEQU, SAA (WSK-WIRE-02)	32
	H03VV-F 3G 0.75mm <sup>2</sup> , APPROVAL: KC, UL BR, VDE, FI, D, N, S, +S, IEMMEQU, SAA (WSK-WIRE-03)	33
	H05VV-F 3G 0.75mm <sup>2</sup> , APPROVAL: KC, UL BR, VDE, FI, D, N, S, +S, IEMMEQU, SAA (WSK-WIRE-04)	34
	H05VV-F 2G 0.75mm <sup>2</sup> (WSK-WIRE-10)	35
	H05VV-F 3G 1.0mm <sup>2</sup>	36
	H05VV-F 3G 1.5mm <sup>2</sup>	37
中國 / CHINA	60227 IEC 52 2X 0.75mm <sup>2</sup>	81
	60227 IEC 53 2X 0.75mm <sup>2</sup>	82
	60227 IEC 52 3G 0.75mm <sup>2</sup>	83
	60227 IEC 53 3G 0.75mm <sup>2</sup>	84
	60227 IEC 53 3*1.0mmSQ	85
日本 / 台灣 JAPAN / TAIWAN	VFF 2 X 0.75mm <sup>2</sup> , FLAT	51
	HVFF 2 X 0.75mm <sup>2</sup> , FLAT	52
	VCTFK 2 X 0.75mm <sup>2</sup> , FLAT (WSK-WIRE-07)	53
	VCTF 2 X 0.75mm <sup>2</sup> , ROUND	54
	VCTF 3 X 0.75mm <sup>2</sup> , ROUND (WSK-WIRE-05)	55
	VCTF 3 X 1.25mm <sup>2</sup> , ROUND (WSK-WIRE-06)	56
	HVCTF 2 X 0.75mm <sup>2</sup> , ROUND	57
	HVCTF 3 X 0.75mm <sup>2</sup> , ROUND	58
	60227 IEC 52 2 X 0.75mm <sup>2</sup>	59
印度 INDIA	YY 2C 0.75mm <sup>2</sup> , FLAT (PVC)	71
	YY 3G 0.75mm <sup>2</sup> , ROUND(PVC)	72

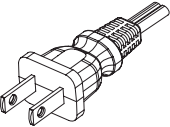
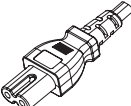

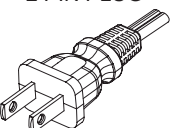
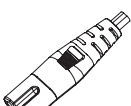

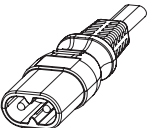
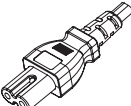





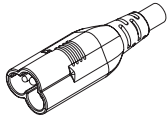
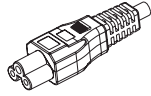

## V. 美國 / 加拿大 AMERICA / CANADA 2PIN

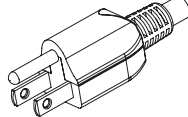
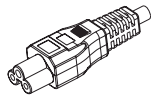
產品號 / 長度 / 公分 P/N / LENGTH / CM	插頭 / 連接器型式 PLUG / CONNECTOR TYPE	PVC 線 PVC WIRE	顏色 COLOR	安規 SAFETY	
V050101-180	WS-004X 2 PIN PLUG  1-15P 10A 125V~	WS-027-5 IEC 60320-1 C7  10A 125V~	 <b>B</b> BLACK		
V050105-100					SPT-2 18/2C/60C
V050105-180					NISPT-2 18/2C/60C
V050102-180					SPT-2 18/2C/105C
V050106-180					NISPT-2 18/2C/105C
V050205-100	WS-004X 2 PIN PLUG  1-15P 10A 125V~	WS-027-8 IEC 60320-1 C7  10A 125V~	 <b>B</b> BLACK	 UL/CUL	
V050201-180					SPT-2 18/2C/60C
V050205-180					NISPT-2 18/2C/60C
V050202-180					SPT-2 18/2C/105C
V050206-180					NISPT-2 18/2C/105C
V280102-180	WS-079-3  IEC 60320-2-2 SHEET C 10A 125V~	WS-027-5 IEC 60320-1 C7  10A 125V~	 <b>B</b> BLACK		
V280106-180					SPT-2 18/2C/105C

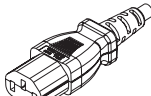
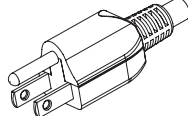
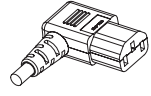

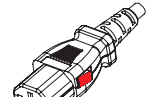
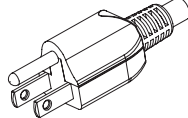
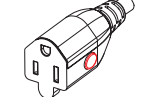







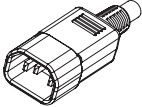
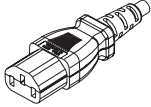

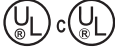
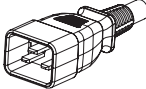
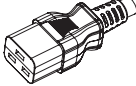
## V. 美國 / 加拿大 AMERICA / CANADA 3PIN

產品號 / 長度 / 公分 P/N / LENGTH / CM	插頭 / 連接器型式 PLUG / CONNECTOR TYPE	PVC 線 PVC WIRE	顏色 COLOR	安規 SAFETY
V270610-180	WS-134-1  IEC 60320-2-2 SHEET A 10A 125V~	WS-083-A IEC 60320-1 C5  10A 125V~	SVT 18/3C/105C	 <b>B</b> BLACK
V010610-100	WS-001-17 3 PIN PLUG  5-15P 10A 125V~	WS-083-A IEC 60320-1 C5  10A 125V~	SVT 18/3C/105C	 <b>B</b> BLACK  UL/CUL
V010610-180		10A 125V~	SVT 18/3C/105C	
V010410-100		WS-002A-3 IEC 60320-1 C13  10A 125V~	SVT 18/3C/105C	
V010410-180		10A 125V~	SVT 18/3C/105C	
V010510-180	WS-001-17 3 PIN PLUG  5-15P 10A 125V~	WS-002A-R4 IEC 60320-1 C13 RIGHT ANGLE  10A 125V~	SVT 18/3C/105C	 <b>B</b> BLACK
V010910-180		WS-002A-4 LOCK IEC 60320-1 C13  10A 125V~	SVT 18/3C/105C	
V010912-180		10A 125V~	SJT 18/3C/105C	
V011914-180	WS-001-17 3 PIN PLUG  5-15P 13A 125V~	WS-022-9 LOCK 5-15R  13A 125V~	SJT 16/3C/105C	 <b>B</b> BLACK Under Applying

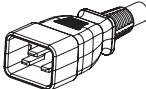



## V. 美國 / 加拿大 AMERICA / CANADA 3PIN



產品號 / 長度 / 公分 P/N / LENGTH / CM	插頭 / 連接器型式 PLUG / CONNECTOR TYPE	PVC 線 PVC WIRE	顏色 COLOR	安規 SAFETY
V250410-180	WS-003-4 IEC 60320-2-2 SHEET E  10A 125V~	WS-002A-3 IEC 60320-1 C13  10A 125V~	SVT 18/3C/105C	 BLACK  UL/CUL
V291214-180	WS-003D-4 (C20) IEC 60320-2-2 SHEET I  13A 125V~	WS-002F-0 IEC 60320-1 C19  13A 125V~	SJT 16/3C/105C	 BLACK Under Applying
V291314-180	13A 125V~	WS-002F-1B IEC 60320-1 C19 RIGHT ANGLE  13A 125V~	SJT 16/3C/105C	UL/CUL By Request
V291414-180	13A 125V~	WS-002F-2B IEC 60320-1 C19 LEFT ANGLE  13A 125V~	SJT 16/3C/105C	UL/CUL By Request
V291514-180	WS-003D-4 (C20) IEC 60320-2-2 SHEET I  13A 125V~	WS-002F-2C IEC 60320-1 C19 LEFT ANGLE LOCK  13A 125V~	SJT 16/3C/105C	 BLACK
V291614-180	13A 125V~	WS-002F-11 IEC 60320-1 C19 STRAIGHT LOCK  13A 125V~	SJT 16/3C/105C	 UL/CUL

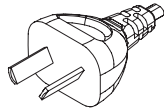
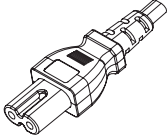

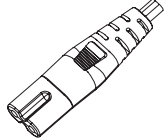
## R. 阿根廷 ARGENTINA 2PIN



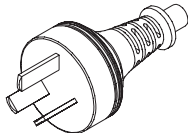
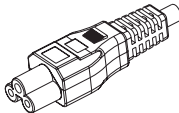

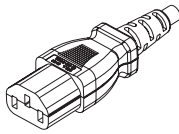
產品號 / 長度 / 公分 P/N / LENGTH / CM	插頭 / 連接器型式 PLUG / CONNECTOR TYPE	PVC 線 PVC WIRE	顏色 COLOR	安規 SAFETY
R110131-180	 WS-009F-1 2 PIN PLUG  10A 250V~	WS-027-5 IEC 60320-1 C7   2.5A 250V~	 BLACK	IRAM By Request
R110132-180		H03VVH2-F 2X0.75mm <sup>2</sup> , APPROVAL: KC, UL BR, VDE, FI, D, N, S, +S, IEMMEQU, SAA		
R110231-100		WS-027-8 IEC 60320-1 C7   2.5A 250V~		
R110231-180		H03VVH2-F 2X0.75mm <sup>2</sup> , APPROVAL: KC, UL BR, VDE, FI, D, N, S, +S, IEMMEQU, SAA		

## R. 阿根廷 ARGENTINA 3PIN

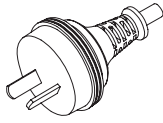
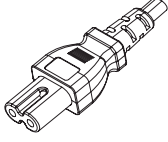

產品號 / 長度 / 公分 P/N / LENGTH / CM	插頭 / 連接器型式 PLUG / CONNECTOR TYPE	PVC 線 PVC WIRE	顏色 COLOR	安規 SAFETY
R020633-180	 WS-015F-1 3 PIN PLUG  10A 250V~	WS-083-A IEC 60320-1 C5   2.5A 250V~	 BLACK	IRAM By Request
R020634-180		H03VV-F 3G 0.75mm <sup>2</sup> , APPROVAL: KC, UL BR, VDE, FI, D, N, S, +S, IEMMEQU, SAA		
R020434-180		WS-002A-3 IEC 60320-1 C13   10A 250V~	H05VV-F 3G 0.75mm <sup>2</sup> , APPROVAL: KC, UL BR, VDE, FI, D, N, S, +S, IEMMEQU, SAA	

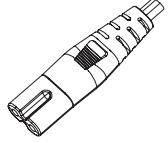

## A. 澳大利亞 AUSTRALIA 2PIN

產品號 / 長度 / 公分 P/N / LENGTH / CM	插頭 / 連接器型式 PLUG / CONNECTOR TYPE	PVC 線 PVC WIRE	顏色 COLOR	安規 SAFETY
A100131-180	 WS-009-2 2 PIN PLUG 10A 250V~	WS-027-5 IEC 60320-1 C7  2.5A 250V~	 BLACK	SAA By Request
A100132-180		H03VVH2-F 2X0.75mm <sup>2</sup> , APPROVAL: KC, UL BR, VDE, FI, D, N, S, +S, IEMMEQU, SAA		
A100231-100		WS-027-8 IEC 60320-1 C7  2.5A 250V~	 BLACK	
A100231-180		H03VVH2-F 2X0.75mm <sup>2</sup> , APPROVAL: KC, UL BR, VDE, FI, D, N, S, +S, IEMMEQU, SAA		
A100232-180		H05VVH2-F 2X 0.75mm <sup>2</sup> , APPROVAL: KC, UL BR, VDE, FI, D, N, S, +S, IEMMEQU, SAA		

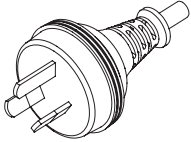
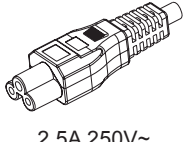
## A. 澳大利亞 AUSTRALIA 3PIN

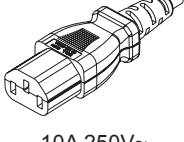
產品號 / 長度 / 公分 P/N / LENGTH / CM	插頭 / 連接器型式 PLUG / CONNECTOR TYPE	PVC 線 PVC WIRE	顏色 COLOR	安規 SAFETY
A170633-180	 WS-015-1 3 PIN PLUG 10A 250V~	WS-083-A IEC 60320-1 C5  2.5A 250V~	 BLACK	SAA By Request
A170634-180		H03VV-F 3G 0.75mm <sup>2</sup> , APPROVAL: KC, UL BR, VDE, FI, D, N, S, +S, IEMMEQU, SAA		
A170434-180		WS-002A-3 IEC 60320-1 C13  10A 250V~	H05VV-F 3G 0.75mm <sup>2</sup> , APPROVAL: KC, UL BR, VDE, FI, D, N, S, +S, IEMMEQU, SAA	



## B. 巴西 BRAZIL 2PIN

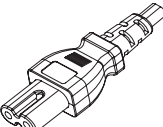
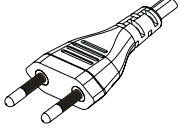
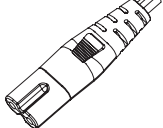

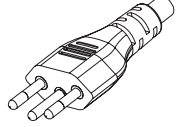
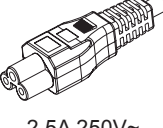
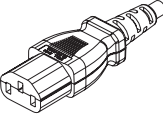

產品號 / 長度 / 公分 P/N / LENGTH / CM	插頭 / 連接器型式 PLUG / CONNECTOR TYPE	PVC 線 PVC WIRE	顏色 COLOR	安規 SAFETY
<b>B540131-180</b>	WS-006G 2 PIN PLUG 	WS-027-5 IEC 60320-1 C7 	B BLACK	INMETRO By Request
<b>B540132-180</b>	10A 250V~	2.5A 250V~		
<b>B540231-100</b>	WS-006G 2 PIN PLUG 	WS-027-8 IEC 60320-1 C7 	B BLACK	
<b>B540231-180</b>	10A 250V~	2.5A 250V~		

## B. 巴西 BRAZIL 3PIN

產品號 / 長度 / 公分 P/N / LENGTH / CM	插頭 / 連接器型式 PLUG / CONNECTOR TYPE	PVC 線 PVC WIRE	顏色 COLOR	安規 SAFETY
<b>B550633-180</b>	WS-311 3 PIN PLUG 	WS-083-A IEC 60320-1 C5 	B BLACK	INMETRO By Request
<b>B550634-180</b>		2.5A 250V~		
<b>B550434-180</b>	10A 250V~	WS-002A-3 IEC 60320-1 C13 	B BLACK	

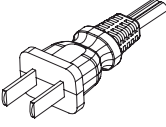
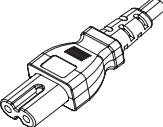

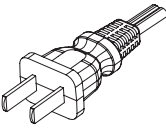
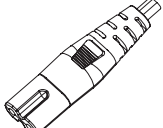



### C. 中國 CHINA 2PIN

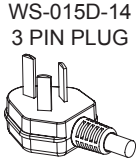
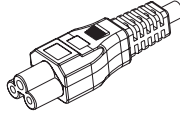

產品號 / 長度 / 公分 P/N / LENGTH / CM	插頭 / 連接器型式 PLUG / CONNECTOR TYPE	PVC 線 PVC WIRE	顏色 COLOR	安規 SAFETY
C030181-100		60227 IEC 52 2X 0.75mm <sup>2</sup>		
C030181-180	WS-004B-7 2 PIN PLUG  10A 250V~	WS-027-5 IEC 60320-1 C7  2.5A 250V~	 BLACK	
C030182-180		60227 IEC 53 2X 0.75mm <sup>2</sup>		
C030281-100		60227 IEC 52 2X 0.75mm <sup>2</sup>		CCC By Request
C030281-180	WS-004B-7 2 PIN PLUG  10A 250V~	WS-027-8 IEC 60320-1 C7  2.5A 250V~	 BLACK	
C030282-180		60227 IEC 53 2X 0.75mm <sup>2</sup>		

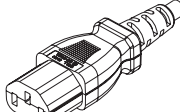

### C. 中國 CHINA 3PIN

產品號 / 長度 / 公分 P/N / LENGTH / CM	插頭 / 連接器型式 PLUG / CONNECTOR TYPE	PVC 線 PVC WIRE	顏色 COLOR	安規 SAFETY	
C320683-180	 WS-015D-14 3 PIN PLUG 10A 250V~	WS-083-A IEC 60320-1 C5  2.5A 250V~	 BLACK	CCC By Request	
C320684-100		60227 IEC 52 3G 0.75mm <sup>2</sup>			
C320684-180		60227 IEC 53 3G 0.75mm <sup>2</sup>			
C320484-100		WS-002A-3 IEC 60320-1 C13  10A 250V~	60227 IEC 53 3G 0.75mm <sup>2</sup>		 BLACK
C320484-180		60227 IEC 53 3G 0.75mm <sup>2</sup>			

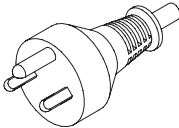
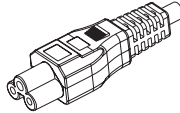
### D. 丹麥 DENMARK 3PIN

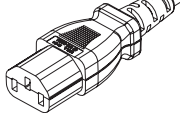
產品號 / 長度 / 公分 P/N / LENGTH / CM	插頭 / 連接器型式 PLUG / CONNECTOR TYPE	PVC 線 PVC WIRE	顏色 COLOR	安規 SAFETY
D610633-180	 WS-008A-1 3 PIN PLUG 10A 250V~	WS-083-A IEC 60320-1 C5  2.5A 250V~	 BLACK	DEMKO By Request
D610634-180		H03VV-F 3G 0.75mm <sup>2</sup> , APPROVAL: KC, UL BR, VDE, FI, D, N, S, +S, IEMMEQU, SAA		
D610434-180		WS-002A-3 IEC 60320-1 C13  10A 250V~	H05VV-F 3G 0.75mm <sup>2</sup> , APPROVAL: KC, UL BR, VDE, FI, D, N, S, +S, IEMMEQU, SAA	









## G. 歐洲 EUROPE 2PIN

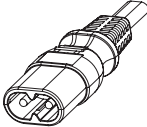
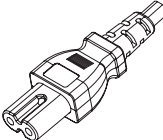

產品號 / 長度 / 公分 P/N / LENGTH / CM	插頭 / 連接器型式 PLUG / CONNECTOR TYPE	PVC 線 PVC WIRE	顏色 COLOR	安規 SAFETY
<b>G070131-180</b>	WS-006-2 2 PIN PLUG 	WS-027-5 IEC 60320-1 C7 	 BLACK	
<b>G070132-180</b>	2.5A 250V~	2.5A 250V~ H05VVH2-F 2X 0.75mm <sup>2</sup> , APPROVAL: KC, UL BR, VDE, FI, D, N, S, +S, IEMMEQU, SAA		
<b>G070231-100</b>	WS-006-2 2 PIN PLUG 	WS-027-8 IEC 60320-1 C7 	 BLACK	 VDE
<b>G070231-180</b>		2.5A 250V~ H03VVH2-F 2X0.75mm <sup>2</sup> , APPROVAL: KC, UL BR, VDE, FI, D, N, S, +S, IEMMEQU, SAA		
<b>G070232-180</b>	2.5A 250V~	H05VVH2-F 2X 0.75mm <sup>2</sup> , APPROVAL: KC, UL BR, VDE, FI, D, N, S, +S, IEMMEQU, SAA		
<b>G330231-180</b>	WS-006-3 EMI 2 PIN PLUG 	WS-027-8 IEC 60320-1 C7 	 BLACK	VDE By Request
<b>G330232-180</b>	2.5A 250V~	2.5A 250V~ H05VVH2-F 2X 0.75mm <sup>2</sup> , APPROVAL: KC, UL BR, VDE, FI, D, N, S, +S, IEMMEQU, SAA		

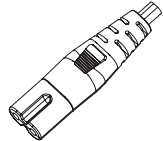

## G. 歐洲 EUROPE 2PIN

產品號 / 長度 / 公分 P/N / LENGTH / CM	插頭 / 連接器型式 PLUG / CONNECTOR TYPE	PVC 線 PVC WIRE	顏色 COLOR	安規 SAFETY
<b>G280131-180</b>	WS-079-3 IEC 60320-2-2 SHEET C   2.5A 250V~	WS-027-5 IEC 60320-1 C7   2.5A 250V~	 BLACK	VDE By Request
<b>G280132-180</b>		H05VVH2-F 2X0.75mm <sup>2</sup> , APPROVAL: KC, UL BR, VDE, FI, D, N, S, +S, IEMMEQU, SAA		
<b>G280231-180</b>		WS-027-8 IEC 60320-1 C7   2.5A 250V~	 BLACK	
<b>G280232-180</b>		H05VVH2-F 2X 0.75mm <sup>2</sup> , APPROVAL: KC, UL BR, VDE, FI, D, N, S, +S, IEMMEQU, SAA		

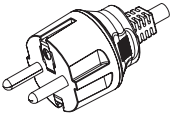
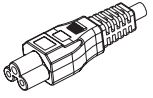
## G. 歐洲 EUROPE 3PIN

產品號 / 長度 / 公分 P/N / LENGTH / CM	插頭 / 連接器型式 PLUG / CONNECTOR TYPE	PVC 線 PVC WIRE	顏色 COLOR	安規 SAFETY
<b>G130633-180</b>	WS-010A-1 3 PIN PLUG   16A 250V~	WS-083-A IEC 60320-1 C5   2.5A 250V~	 BLACK	VDE By Request
<b>G130634-180</b>		H03VV-F 3G 0.75mm <sup>2</sup> , APPROVAL: KC, UL BR, VDE, FI, D, N, S, +S, IEMMEQU, SAA		
		H05VV-F 3G 0.75mm <sup>2</sup> , APPROVAL: KC, UL BR, VDE, FI, D, N, S, +S, IEMMEQU, SAA		





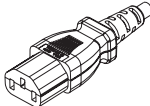
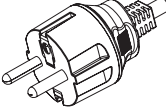
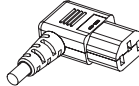
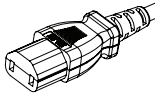
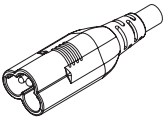
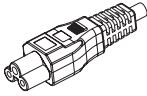
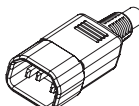
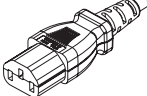

## G. 歐洲 EUROPE 3PIN



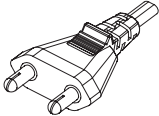
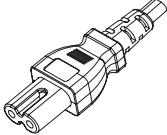

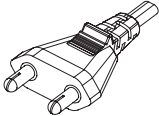
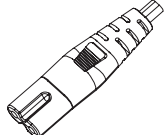
產品號 / 長度 / 公分 P/N / LENGTH / CM	插頭 / 連接器型式 PLUG / CONNECTOR TYPE	PVC 線 PVC WIRE	顏色 COLOR	安規 SAFETY
G130434-180		WS-002A-3 IEC 60320-1 C13  16A 250V~		
G130534-180	WS-010A-1 3 PIN PLUG  16A 250V~	WS-002A-R4 IEC 60320-1 C13 RIGHT ANGLE  16A 250V~		
G131135-180		WS-002E-3 IEC 60320-1 C17  16A 250V~		
G270633-180	WS-134-1 IEC 60320-2-2 SHEET A  2.5A 250V~	WS-083-A IEC 60320-1 C5  2.5A 250V~		VDE By Request
G270634-180				
G250434-180	WS-003-4 IEC 60320-2-2 SHEET E  10A 250V~	WS-002A-3 IEC 60320-1 C13  10A 250V~		



## I. 印度 INDIA 2PIN

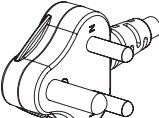
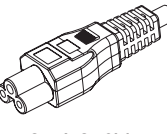

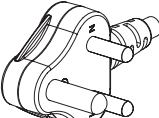
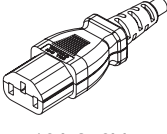

產品號 / 長度 / 公分 P/N / LENGTH / CM	插頭 / 連接器型式 PLUG / CONNECTOR TYPE	PVC 線 PVC WIRE	顏色 COLOR	安規 SAFETY	
I210171-180	WS-006F-1 2 PIN PLUG 	WS-027-5 IEC 60320-1 C7  2.5A 250V~	YY 2C 0.75mm <sup>2</sup> , FLAT (PVC)	 <b>B</b> BLACK	 BIS
I210271-180	 2.5A 250V~	WS-027-8 IEC 60320-1 C7  2.5A 250V~	YY 2C 0.75mm <sup>2</sup> , FLAT (PVC)	 <b>B</b> BLACK	

## I. 印度 INDIA 3PIN

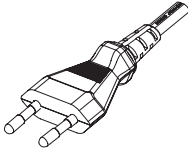
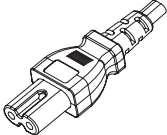

產品號 / 長度 / 公分 P/N / LENGTH / CM	插頭 / 連接器型式 PLUG / CONNECTOR TYPE	PVC 線 PVC WIRE	顏色 COLOR	安規 SAFETY	
I200672-180	WS-018-B 3 PIN PLUG 	WS-083-A IEC 60320-1 C5  2.5A 250V~	YY 3G 0.75mm <sup>2</sup> , ROUND (PVC)	 <b>B</b> BLACK	 BIS
I200472-180	 10A 250V~	WS-002A-3 IEC 60320-1 C13  10A 250V~	YY 3G 0.75mm <sup>2</sup> , ROUND (PVC)	 <b>B</b> BLACK	

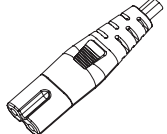

## L. 以色列 ISRAEL 2PIN



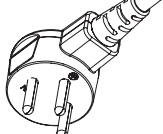
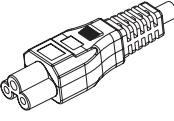

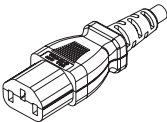
產品號 / 長度 / 公分 P/N / LENGTH / CM	插頭 / 連接器型式 PLUG / CONNECTOR TYPE	PVC 線 PVC WIRE	顏色 COLOR	安規 SAFETY
L070131-180	 WS-006-2 2 PIN PLUG  2.5A 250V~	WS-027-5 IEC 60320-1 C7   2.5A 250V~	 BLACK	 SII
L070132-180		H03VVH2-F 2X0.75mm <sup>2</sup> , APPROVAL: KC, UL BR, VDE, FI, D, N, S, +S, IEMMEQU, SAA		
L070231-180		WS-027-8 IEC 60320-1 C7   2.5A 250V~	 BLACK	
L070232-180		H05VVH2-F 2X 0.75mm <sup>2</sup> , APPROVAL: KC, UL BR, VDE, FI, D, N, S, +S, IEMMEQU, SAA		

## L. 以色列 ISRAEL 3PIN

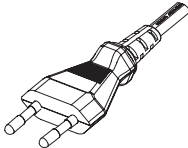
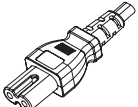

產品號 / 長度 / 公分 P/N / LENGTH / CM	插頭 / 連接器型式 PLUG / CONNECTOR TYPE	PVC 線 PVC WIRE	顏色 COLOR	安規 SAFETY
L340633-180	 WS-020-B 3 PIN PLUG  10A 250V~	WS-083-A IEC 60320-1 C5   2.5A 250V~	 BLACK	 SII
L340634-180		H03VV-F 3G 0.75mm <sup>2</sup> , APPROVAL: KC, UL BR, VDE, FI, D, N, S, +S, IEMMEQU, SAA		
L340434-180		WS-002A-3 IEC 60320-1 C13   10A 250V~	H05VV-F 3G 0.75mm <sup>2</sup> , APPROVAL: KC, UL BR, VDE, FI, D, N, S, +S, IEMMEQU, SAA	

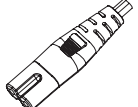

## X. 義大利 ITALY 2PIN



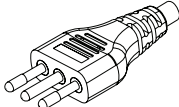
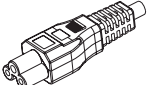

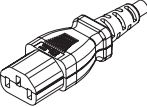

產品號 / 長度 / 公分 P/N / LENGTH / CM	插頭 / 連接器型式 PLUG / CONNECTOR TYPE	PVC 線 PVC WIRE	顏色 COLOR	安規 SAFETY
X070131-180	 WS-006-2 2 PIN PLUG  2.5A 250V~	WS-027-5 IEC 60320-1 C7   2.5A 250V~	 BLACK	IMQ By Request
X070132-180		H05VVH2-F 2X 0.75mm <sup>2</sup> , APPROVAL: KC, UL BR, VDE, FI, D, N, S, +S, IEMMEQU, SAA		
X070231-180		WS-027-8 IEC 60320-1 C7   2.5A 250V~	 BLACK	
X070232-180		H05VVH2-F 2X 0.75mm <sup>2</sup> , APPROVAL: KC, UL BR, VDE, FI, D, N, S, +S, IEMMEQU, SAA		

## X. 義大利 ITALY 3PIN

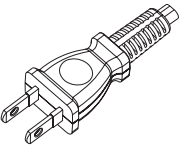
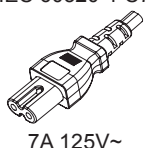
產品號 / 長度 / 公分 P/N / LENGTH / CM	插頭 / 連接器型式 PLUG / CONNECTOR TYPE	PVC 線 PVC WIRE	顏色 COLOR	安規 SAFETY
X150633-180	 WS-013-1 3 PIN PLUG  10A 250V~	WS-083-A IEC 60320-1 C5   2.5A 250V~	 BLACK	IMQ By Reques
X150634-180		H03VV-F 3G 0.75mm <sup>2</sup> , APPROVAL: KC, UL BR, VDE, FI, D, N, S, +S, IEMMEQU, SAA		
X150434-180		WS-002A-3 IEC 60320-1 C13   10A 250V~	H05VV-F 3G 0.75mm <sup>2</sup> , APPROVAL: KC, UL BR, VDE, FI, D, N, S, +S, IEMMEQU, SAA	

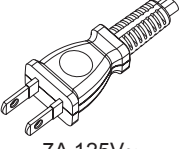
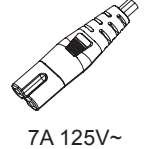

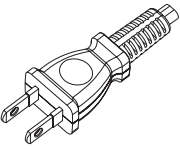
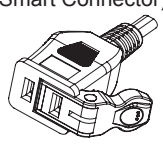



## J. 日本 JAPAN 2PIN



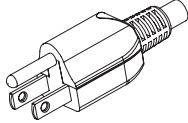
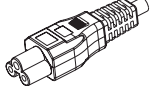

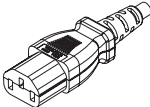
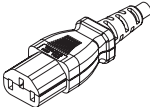
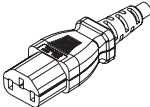
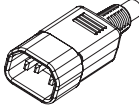
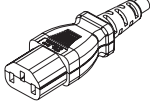
產品號 / 長度 / 公分 P/N / LENGTH / CM	插頭 / 連接器型式 PLUG / CONNECTOR TYPE	PVC 線 PVC WIRE	顏色 COLOR	安規 SAFETY	
J060151-180	WS-005C-8 半絕緣 2 PIN PLUG  7A 125V~	WS-027-5 IEC 60320-1 C7  7A 125V~	 <b>B</b> BLACK		
J060152-180					HVFF 2X0.75mm <sup>2</sup>
J060153-180					VCTFK 2X0.75mm <sup>2</sup>
J060251-180	WS-005C-8 半絕緣 2 PIN PLUG  7A 125V~	WS-027-8 IEC 60320-1 C7  7A 125V~	 <b>B</b> BLACK	 JET PSE	
J060252-180					HVFF 2X0.75mm <sup>2</sup>
J060253-180					VCTFK 2X0.75mm <sup>2</sup>
J061753-180	WS-005C-8 半絕緣 2 PIN PLUG  7A 125V~	WS-026-8 (Easy-Pull Smart Connector)  7A 125V~	VCTFK 2X0.75mm <sup>2</sup>	 <b>B</b> BLACK	

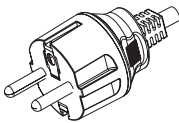
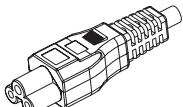

## J. 日本 JAPAN 3PIN

產品號 / 長度 / 公分 P/N / LENGTH / CM	插頭 / 連接器型式 PLUG / CONNECTOR TYPE	PVC 線 PVC WIRE	顏色 COLOR	安規 SAFETY
J010655-100	 WS-001-17 3 PIN PLUG 7A 125V~	WS-083-A IEC 60320-1 C5  7A 125V~ VCTF 3X0.75mm <sup>2</sup>	 <b>B</b> BLACK	 PSE
J010655-180		WS-002A-3 IEC 60320-1 C13  7A 125V~ VCTF 3X0.75mm <sup>2</sup>		
J010455-180		WS-002A-3 IEC 60320-1 C13  7A 125V~ HVCTF 3X0.75mm <sup>2</sup>		
J010458-180		WS-002A-3 IEC 60320-1 C13  7A 125V~ VCTF 3X0.75mm <sup>2</sup>		
J250455-180	WS-003-4 IEC 60320-2-2 SHEET E  7A 125V~	WS-002A-3 IEC 60320-1 C13  7A 125V~ VCTF 3X0.75mm <sup>2</sup>	 <b>B</b> BLACK	

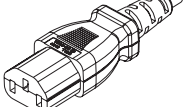
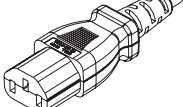

## K. 韓國 KOREA 3PIN

產品號 / 長度 / 公分 P/N / LENGTH / CM	插頭 / 連接器型式 PLUG / CONNECTOR TYPE	PVC 線 PVC WIRE	顏色 COLOR	安規 SAFETY
K130633-180	 WS-010A-1 3 PIN PLUG 16A 250V~	WS-083-A IEC 60320-1 C5  2.5A 250V~ H03VV-F 3G 0.75mm <sup>2</sup> , APPROVAL: KC, UL BR, VDE, FI, D, N, S, +S, IEMMEQU, SAA	 <b>B</b> BLACK	KTC By Request
K130634-180		WS-002A-3 IEC 60320-1 C13  10A 250V~ H05VV-F 3G 0.75mm <sup>2</sup> , APPROVAL: KC, UL BR, VDE, FI, D, N, S, +S, IEMMEQU, SAA		
K130434-180		WS-002A-3 IEC 60320-1 C13  10A 250V~ H05VV-F 3G 0.75mm <sup>2</sup> , APPROVAL: KC, UL BR, VDE, FI, D, N, S, +S, IEMMEQU, SAA	 <b>B</b> BLACK	





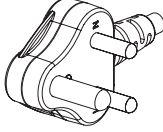
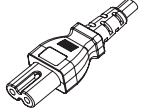

## S. 南非 SOUTH AFRICA 2PIN

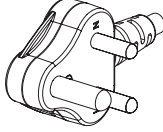
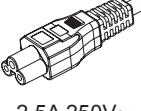

產品號 / 長度 / 公分 P/N / LENGTH / CM	插頭 / 連接器型式 PLUG / CONNECTOR TYPE	PVC 線 PVC WIRE	顏色 COLOR	安規 SAFETY
S200131-180	<p>WS-018-B</p>  <p>6A 250V~</p>	<p>WS-027-5 IEC 60320-1 C7</p>  <p>2.5A 250V~</p>	 BLACK	SABS By Request
S200132-180		<p>H03VVH2-F 2X0.75mm<sup>2</sup>, APPROVAL: KC, UL BR, VDE, FI, D, N, S, +S, IEMMEQU, SAA</p> <hr/> <p>H05VVH2-F 2X 0.75mm<sup>2</sup>, APPROVAL: KC, UL BR, VDE, FI, D, N, S, +S, IEMMEQU, SAA</p>		

## S. 南非 SOUTH AFRICA 3PIN



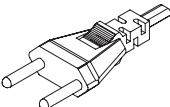
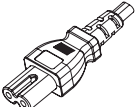

產品號 / 長度 / 公分 P/N / LENGTH / CM	插頭 / 連接器型式 PLUG / CONNECTOR TYPE	PVC 線 PVC WIRE	顏色 COLOR	安規 SAFETY
S200633-180	<p>WS-018-B 3 PIN PLUG</p>  <p>6A 250V~</p>	<p>WS-083-A IEC 60320-1 C5</p>  <p>2.5A 250V~</p>	 BLACK	SABS By Request
S200634-180		<p>H03VV-F 3G 0.75mm<sup>2</sup>, APPROVAL: KC, UL BR, VDE, FI, D, N, S, +S, IEMMEQU, SAA</p> <hr/> <p>H05VV-F 3G 0.75mm<sup>2</sup>, APPROVAL: KC, UL BR, VDE, FI, D, N, S, +S, IEMMEQU, SAA</p>		

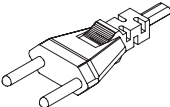
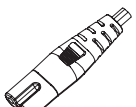

## Z. 瑞士 SWITZERLAND 2PIN

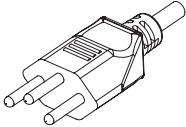
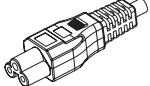

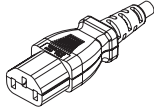

產品號 / 長度 / 公分 P/N / LENGTH / CM	插頭 / 連接器型式 PLUG / CONNECTOR TYPE	PVC 線 PVC WIRE	顏色 COLOR	安規 SAFETY
Z790131-180	WS-014A 2 PIN PLUG 	WS-027-5 IEC 60320-1 C7 	 BLACK	SEV By Request
Z790132-180	10A 250V~	2.5A 250V~		
Z790231-100	WS-014A 2 PIN PLUG 	WS-027-8 IEC 60320-1 C7 		
Z790231-180	10A 250V~	2.5A 250V~		

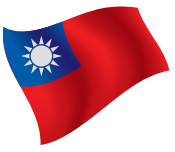
## Z. 瑞士 SWITZERLAND 3PIN



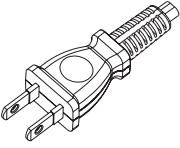
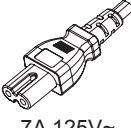

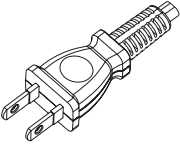
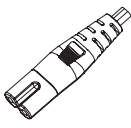
產品號 / 長度 / 公分 P/N / LENGTH / CM	插頭 / 連接器型式 PLUG / CONNECTOR TYPE	PVC 線 PVC WIRE	顏色 COLOR	安規 SAFETY
Z160633-180	WS-014-1 3 PIN PLUG  10A 250V~	WS-083-A IEC 60320-1 C5 	 BLACK	SEV By Request
Z160634-180		2.5A 250V~		
Z160434-180	10A 250V~	WS-002A-3 IEC 60320-1 C13 	 BLACK	



## T. 台灣 TAIWAN 2PIN

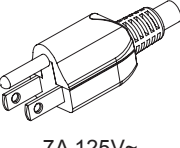
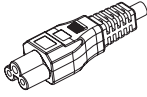

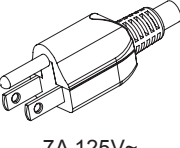
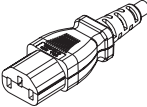





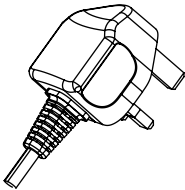
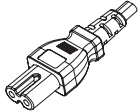

產品號 / 長度 / 公分 P/N / LENGTH / CM	插頭 / 連接器型式 PLUG / CONNECTOR TYPE	PVC 線 PVC WIRE	顏色 COLOR	安規 SAFETY
T060153-100	WS-005C-8 2 PIN PLUG  7A 125V~	WS-027-5 IEC 60320-1 C7  7A 125V~	 BLACK	BSMI By Request
T060153-180		VCTFK 2X0.75mm <sup>2</sup>		
T060253-100	WS-005C-8 2 PIN PLUG  7A 125V~	WS-027-8 IEC 60320-1 C7  7A 125V~	 BLACK	 BSMI
T060253-180		VCTFK 2X0.75mm <sup>2</sup>		

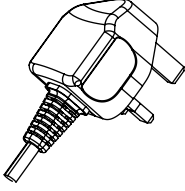
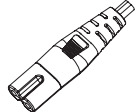
## T. 台灣 TAIWAN 3PIN

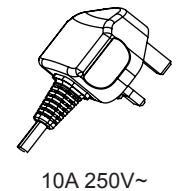
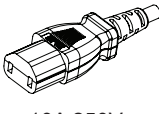
產品號 / 長度 / 公分 P/N / LENGTH / CM	插頭 / 連接器型式 PLUG / CONNECTOR TYPE	PVC 線 PVC WIRE	顏色 COLOR	安規 SAFETY
T010655-100	WS-001-17 3 PIN PLUG  7A 125V~	WS-083-A IEC 60320-1 C5  7A 125V~	 BLACK	BSMI By Request
T010655-180		VCTF 3X0.75mm <sup>2</sup>		
T010455-180	WS-001-17 3 PIN PLUG  7A 125V~	WS-002A-3 IEC 60320-1 C13  7A 125V~	 BLACK	BSMI By Request
T010455-180		VCTF 3X0.75mm <sup>2</sup>		

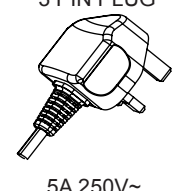
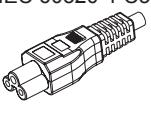

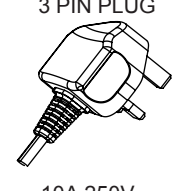
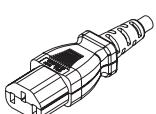







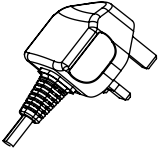
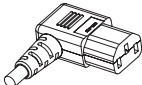

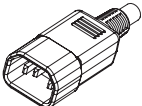
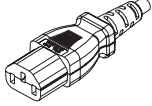
## U. 英國 UNITED KINGDOM 3PIN

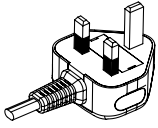
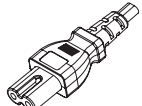
產品號 / 長度 / 公分 P/N / LENGTH / CM	插頭 / 連接器型式 PLUG / CONNECTOR TYPE	PVC 線 PVC WIRE	顏色 COLOR	安規 SAFETY
U140131-100	WS-012E 3 PIN PLUG 	WS-027-5 IEC 60320-1 C7 	 BLACK	
U140131-180		H03VVH2-F 2X0.75mm <sup>2</sup> , APPROVAL: KC, UL BR, VDE, FI, D, N, S, +S, IEMMEQU, SAA		
U140132-180	5A 250V~	2.5A 250V~ H05VVH2-F 2X 0.75mm <sup>2</sup> , APPROVAL: KC, UL BR, VDE, FI, D, N, S, +S, IEMMEQU, SAA		
U140231-180	WS-012E 3 PIN PLUG 	WS-027-8 IEC 60320-1 C7 	 BLACK	
U140232-180	5A 250V~	2.5A 250V~ H05VVH2-F 2X 0.75mm <sup>2</sup> , APPROVAL: KC, UL BR, VDE, FI, D, N, S, +S, IEMMEQU, SAA		
U141135-180	WS-012E 3 PIN PLUG 	WS-002E-3 IEC 60320-1 C17 	 BLACK	 BSI
U140633-180	WS-012E 3 PIN PLUG 	WS-083-A IEC 60320-1 C5 	 BLACK	
U140634-100		H03VV-F 3G 0.75mm <sup>2</sup> , APPROVAL: KC, UL BR, VDE, FI, D, N, S, +S, IEMMEQU, SAA		
U140634-180	5A 250V~	2.5A 250V~ H05VV-F 3G 0.75mm <sup>2</sup> , APPROVAL: KC, UL BR, VDE, FI, D, N, S, +S, IEMMEQU, SAA		
U140434-100	WS-012E 3 PIN PLUG 	WS-002A-3 IEC 60320-1 C13 	 BLACK	
U140434-180	10A 250V~	10A 250V~ H05VV-F 3G 0.75mm <sup>2</sup> , APPROVAL: KC, UL BR, VDE, FI, D, N, S, +S, IEMMEQU, SAA		

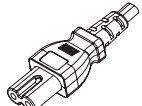
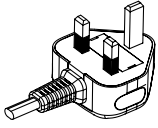
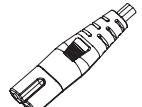

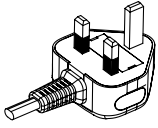
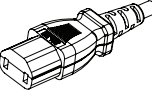





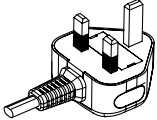
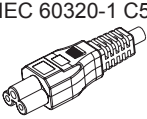

## U. 英國 UNITED KINGDOM 3PIN

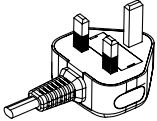
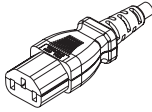
產品號 / 長度 / 公分 P/N / LENGTH / CM	插頭 / 連接器型式 PLUG / CONNECTOR TYPE	PVC 線 PVC WIRE	顏色 COLOR	安規 SAFETY
U140534-180	WS-012E 3 PIN PLUG  10A 250V~	WS-002A-R4 IEC 60320-1 C13 RIGHT ANGLE  10A 250V~	H05VV-F 3G 0.75mm <sup>2</sup> , APPROVAL: KC, UL BR, VDE, FI, D, N, S, +S, IEMMEQU, SAA	 <b>B</b> BLACK
U250434-180	WS-003-4 IEC 60320-2-2 SHEET E  10A 250V~	WS-002A-3 IEC 60320-1 C13  10A 250V~	H05VV-F 3G 0.75mm <sup>2</sup> , APPROVAL: KC, UL BR, VDE, FI, D, N, S, +S, IEMMEQU, SAA	 <b>B</b> BLACK
U120131-100	WS-012E-1 3 PIN PLUG  5A 250V~	WS-027-5 IEC 60320-1 C7  2.5A 250V~	H03VVH2-F 2X0.75mm <sup>2</sup> , APPROVAL: KC, UL BR, VDE, FI, D, N, S, +S, IEMMEQU, SAA	 <b>B</b> BLACK  BSI By Request
U120131-180		WS-027-5 IEC 60320-1 C7  2.5A 250V~	H03VVH2-F 2X0.75mm <sup>2</sup> , APPROVAL: KC, UL BR, VDE, FI, D, N, S, +S, IEMMEQU, SAA	
U120132-180			H05VVH2-F 2X 0.75mm <sup>2</sup> , APPROVAL: KC, UL BR, VDE, FI, D, N, S, +S, IEMMEQU, SAA	
U120231-180	WS-012E-1 3 PIN PLUG  5A 250V~	WS-027-8 IEC 60320-1 C7  2.5A 250V~	H03VVH2-F 2X0.75mm <sup>2</sup> , APPROVAL: KC, UL BR, VDE, FI, D, N, S, +S, IEMMEQU, SAA	 <b>B</b> BLACK
U120232-180			H05VVH2-F 2X 0.75mm <sup>2</sup> , APPROVAL: KC, UL BR, VDE, FI, D, N, S, +S, IEMMEQU, SAA	
U121135-180	WS-012E-1 3 PIN PLUG  10A 250V~	WS-002E-3 IEC 60320-1 C17  10A 250V~	60227 IEC 53 + H05VV-F 2X0.75mm <sup>2</sup> , APPROVAL: KC, UL BR, VDE, FI, D, N, S, +S, IEMMEQU, SAA	 <b>B</b> BLACK

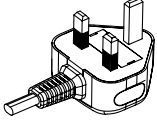
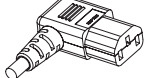

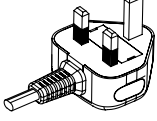
## U. 英國 UNITED KINGDOM 3PIN

產品號 / 長度 / 公分 P/N / LENGTH / CM	插頭 / 連接器型式 PLUG / CONNECTOR TYPE	PVC 線 PVC WIRE	顏色 COLOR	安規 SAFETY
U120633-180	WS-012E-1 3 PIN PLUG  5A 250V~	WS-083-A IEC 60320-1 C5  2.5A 250V~	 BLACK	BSI By Request
U120634-100		H03VV-F 3G 0.75mm <sup>2</sup> , APPROVAL: KC, UL BR, VDE, FI, D, N, S, +S, IEMMEQU, SAA		
U120634-180		H05VV-F 3G 0.75mm <sup>2</sup> , APPROVAL: KC, UL BR, VDE, FI, D, N, S, +S, IEMMEQU, SAA		
U120434-100	WS-012E-1 3 PIN PLUG  10A 250V~	WS-002A-3 IEC 60320-1 C13  10A 250V~	 BLACK	
U120434-180		H05VV-F 3G 0.75mm <sup>2</sup> , APPROVAL: KC, UL BR, VDE, FI, D, N, S, +S, IEMMEQU, SAA		
U120534-180	WS-012E-1 3 PIN PLUG  10A 250V~	WS-002A-R4 IEC 60320-1 C13 RIGHT ANGLE  10A 250V~	 BLACK	
U120231-100		WS-027-8 IEC 60320-1 C7  2.5A 250V~		
U120231-100	WS-012E-1 3 PIN PLUG  10A 250V~	H03VVH2-F 2X0.75mm <sup>2</sup> , APPROVAL: KC, UL BR, VDE, FI, D, N, S, +S, IEMMEQU, SAA	 BLACK	

# 無鹵線材編碼原則

## HALOGEN FREE CABLE (HF) ENCODING PRINCIPLE

國別 COUNTRY	線材 CABLE	編號 CODE
美國 / 加拿大 USA / CANADA	SVE 18 / 3C / 60C	A
	SPE-2 18 / 2C	B
	NISPE-2 18 / 2C	C
歐州 / 阿根廷 / 英國 / 澳洲 / 丹麥 / 義大利 / 南非 / 瑞士  EUROPEAN / ARGENTINA/ UK / AUSTRALIA / DENMARK / ITALY / SOUTH AFRICA / SWITZERLAND	H03Z1Z1H2-F 2 X 0.75mm <sup>2</sup>	D
	H05Z1Z1H2-F 2 X 0.75mm <sup>2</sup>	E
	H03Z1Z1-F 3 X 0.75mm <sup>2</sup>	F
	H05Z1Z1-F 3 X 0.75mm <sup>2</sup>	G
	H05Z1Z1-F 2 X 0.75mm <sup>2</sup>	O
日本 / JAPAN	EM-OFF/F 2 X 0.75mm <sup>2</sup>	H
	EM-OOCTF/F 2 X 0.75mm <sup>2</sup>	I
	EM-OOCTFK/F 2 X 0.75mm <sup>2</sup>	J
	EM-ECTFK 2 X 0.75mm <sup>2</sup>	K
	EM-CCTF 2 X 0.75mm <sup>2</sup>	L
	OOCTF/F 3 X 0.75mm <sup>2</sup>	M
	EM-ECTF 3 X 0.75mm <sup>2</sup>	N









**HF**

www.wellshin.com.tw

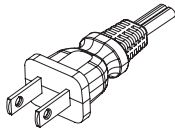
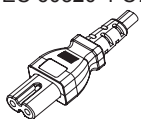
**POWER CORD SET**

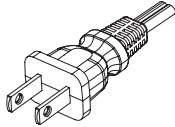
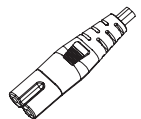

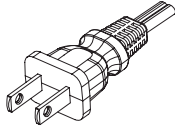
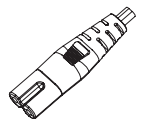

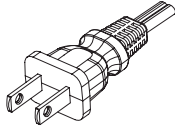
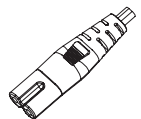



V. 美國 / 加拿大 AMERICA / CANADA 2PIN

產品號 / 長度 / 公分 P/N / LENGTH / CM	插頭 / 連接器型式 PLUG / CONNECTOR TYPE	無鹵線 (HF) WIRE	顏色 COLOR	安規 SAFETY	
V0501BHF-180	WS-004X 2 PIN PLUG  1-15P 10A 125V~	WS-027-5 IEC 60320-1 C7  10A 125V~	SPE-2 18/2C	 BLACK	
V0501CHF-180	WS-004X 2 PIN PLUG  1-15P 10A 125V~	WS-027-8 IEC 60320-1 C7  10A 125V~	NISPE-2 18/2C	 UL/CUL	
V0502BHF-180	WS-004X 2 PIN PLUG  1-15P 10A 125V~	WS-027-8 IEC 60320-1 C7  10A 125V~	SPE-2 18/2C	 BLACK	
V0502CHF-180	WS-004X 2 PIN PLUG  1-15P 10A 125V~	WS-027-8 IEC 60320-1 C7  10A 125V~	NISPE-2 18/2C		

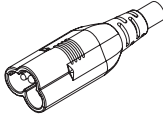
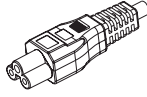

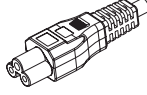
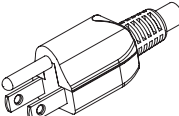
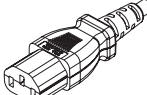

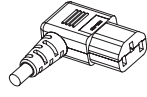
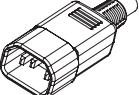
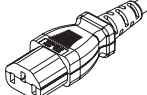

## V. 美國 / 加拿大 AMERICA / CANADA 3PIN



產品號 / 長度 / 公分 P/N / LENGTH / CM	插頭 / 連接器型式 PLUG / CONNECTOR TYPE	無鹵線 (HF) WIRE	顏色 COLOR	安規 SAFETY	
V2706AHF-180	WS-134-1  IEC 60320-2-2 SHEET A 10A 125V~	WS-083-A IEC 60320-1 C5  10A 125V~	SVE 18/3C/60C	 BLACK	
V0106AHF-180		WS-083-A IEC 60320-1 C5  10A 125V~	SVE 18/3C/60C		
V0104AHF-180	WS-001-17 3 PIN PLUG  5-15P 10A 125V~	WS-002A-3 IEC 60320-1 C13  10A 125V~	SVE 18/3C/60C	 BLACK	 UL/CUL
V0105AHF-180		WS-002A-R4 IEC 60320-1 C13 RIGHT ANGLE  10A 125V~	SVE 18/3C/60C		
V2504AHF-180	WS-003-4 IEC 60320-2-2 SHEET E  10A 125V~	WS-002A-3 IEC 60320-1 C13  10A 125V~	SVE 18/3C/60C	 BLACK	UL/CUL By Request

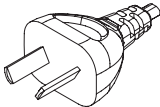
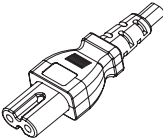

## R. 阿根廷 ARGENTINA 2PIN



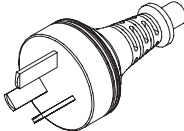
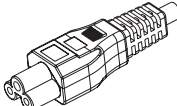

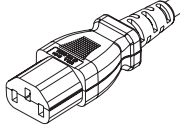
產品號 / 長度 / 公分 P/N / LENGTH / CM	插頭 / 連接器型式 PLUG / CONNECTOR TYPE	無鹵線 (HF) WIRE	顏色 COLOR	安規 SAFETY
<b>R1101DHF-180</b>	WS-009F-1 2 PIN PLUG  10A 250V~	WS-027-5 IEC 60320-1 C7  2.5A 250V~	 <b>B</b> BLACK	IRAM By Request
<b>R1101EHF-180</b>		H03Z1Z1H2-F 2X0.75mm <sup>2</sup>		
		H05Z1Z1H2-F 2X0.75mm <sup>2</sup>		

## R. 阿根廷 ARGENTINA 3PIN

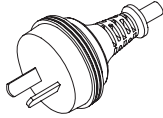
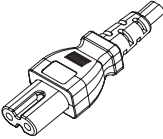

產品號 / 長度 / 公分 P/N / LENGTH / CM	插頭 / 連接器型式 PLUG / CONNECTOR TYPE	無鹵線 (HF) WIRE	顏色 COLOR	安規 SAFETY
<b>R0206FHF-180</b>	WS-015F-1 3 PIN PLUG  10A 250V~	WS-083-A IEC 60320-1 C5  2.5A 250V~	 <b>B</b> BLACK	IRAM By Request
<b>R0206GHF-180</b>		H03Z1Z1-F 3X0.75mm <sup>2</sup>		
<b>R0204GHF-180</b>		WS-002A-3 IEC 60320-1 C13  10A 250V~	H05Z1Z1-F 3X0.75mm <sup>2</sup>	

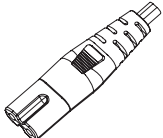

## A. 澳大利亞 AUSTRALIA 2PIN

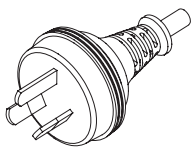
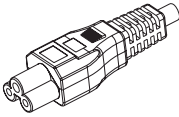

產品號 / 長度 / 公分 P/N / LENGTH / CM	插頭 / 連接器型式 PLUG / CONNECTOR TYPE	無鹵線 (HF) WIRE	顏色 COLOR	安規 SAFETY
A1001DHF-180	 WS-009-2 2 PIN PLUG 10A 250V~	WS-027-5 IEC 60320-1 C7  2.5A 250V~	 BLACK	SAA By Request
A1001EHF-180		H03Z1Z1H2-F 2X0.75mm <sup>2</sup>		
A1002DHF-180		WS-027-8 IEC 60320-1 C7  2.5A 250V~	 BLACK	
A1002EHF-180		H05Z1Z1H2-F 2X0.75mm <sup>2</sup>		

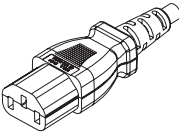
## A. 澳大利亞 AUSTRALIA 3PIN



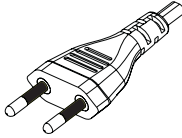
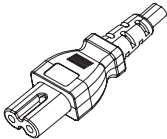

產品號 / 長度 / 公分 P/N / LENGTH / CM	插頭 / 連接器型式 PLUG / CONNECTOR TYPE	無鹵線 (HF) WIRE	顏色 COLOR	安規 SAFETY
A1706FHF-180	 WS-015-1 3 PIN PLUG 10A 250V~	WS-083-A IEC 60320-1 C5  2.5A 250V~	 BLACK	SAA By Request
A1706GHF-180		H03Z1Z1-F 3X0.75mm <sup>2</sup>		
A1704GHF-180		WS-002A-3 IEC 60320-1 C13  10A 250V~	H05Z1Z1-F 3X0.75mm <sup>2</sup>	



## B. 巴西 BRAZIL 2PIN

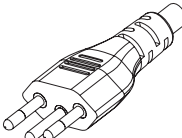
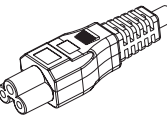

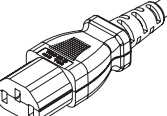
產品號 / 長度 / 公分 P/N / LENGTH / CM	插頭 / 連接器型式 PLUG / CONNECTOR TYPE	無鹵線 (HF) WIRE	顏色 COLOR	安規 SAFETY
<b>B5401DHF-180</b>	WS-006G 2 PIN PLUG  10A 250V~	WS-027-5 IEC 60320-1 C7  2.5A 250V~	 BLACK	INMETRO By Request
<b>B5401EHF-180</b>		H03Z1Z1H2-F 2X0.75mm <sup>2</sup> H05Z1Z1H2-F 2X0.75mm <sup>2</sup>		

## B. 巴西 BRAZIL 3PIN

產品號 / 長度 / 公分 P/N / LENGTH / CM	插頭 / 連接器型式 PLUG / CONNECTOR TYPE	無鹵線 (HF) WIRE	顏色 COLOR	安規 SAFETY
<b>B5506FHF-180</b>	WS-311 3 PIN PLUG  10A 250V~	WS-083-A IEC 60320-1 C5  2.5A 250V~	 BLACK	INMETRO By Request
<b>B5506GHF-180</b>		H03Z1Z1-F 3X0.75mm <sup>2</sup> H05Z1Z1-F 3X0.75mm <sup>2</sup>		
<b>B5504GHF-180</b>		WS-002A-3 IEC 60320-1 C13  10A 250V~	H05Z1Z1-F 3X0.75mm <sup>2</sup>	 BLACK

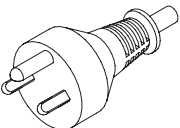
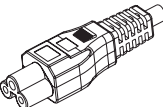

## D. 丹麥 DENMARK 3PIN

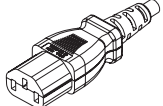



產品號 / 長度 / 公分 P/N / LENGTH / CM	插頭 / 連接器型式 PLUG / CONNECTOR TYPE	無鹵線 (HF) WIRE	顏色 COLOR	安規 SAFETY
D6106FHF-180	 WS-008A-1 3 PIN PLUG  10A 250V~	WS-083-A IEC 60320-1 C5   2.5A 250V~	 BLACK	DEMKO By Request
D6106GHF-180		H03Z1Z1-F 3X0.75mm <sup>2</sup>		
D6104GHF-180		WS-002A-3 IEC 60320-1 C13   10A 250V~	H05Z1Z1-F 3X0.75mm <sup>2</sup>	

## G. 歐洲 EUROPE 2PIN



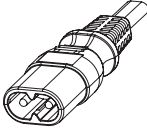
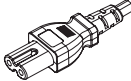

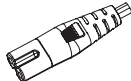



產品號 / 長度 / 公分 P/N / LENGTH / CM	插頭 / 連接器型式 PLUG / CONNECTOR TYPE	無鹵線 (HF) WIRE	顏色 COLOR	安規 SAFETY	
G0701DHF-180	 WS-006-2 2 PIN PLUG  2.5A 250V~	WS-027-5 IEC 60320-1 C7   2.5A 250V~	 BLACK	 VDE	
G0701EHF-180		H03Z1Z1H2-F 2X0.75mm <sup>2</sup>			
G0702DHF-180		WS-027-8 IEC 60320-1 C7   2.5A 250V~			H03Z1Z1H2-F 2X0.75mm <sup>2</sup>
G0702EHF-180		H05Z1Z1H2-F 2X0.75mm <sup>2</sup>			
G3302DHF-180	WS-006-3 EMI 2 PIN PLUG   2.5A 250V~	WS-027-8 IEC 60320-1 C7   2.5A 250V~	 BLACK	VDE By Request	
G3302EHF-180		H03Z1Z1H2-F 2X0.75mm <sup>2</sup>			
		H05Z1Z1H2-F 2X0.75mm <sup>2</sup>			

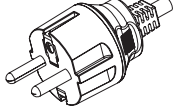
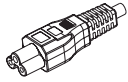

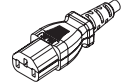
## G. 歐洲 EUROPE 2PIN

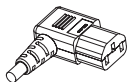
產品號 / 長度 / 公分 P/N / LENGTH / CM	插頭 / 連接器型式 PLUG / CONNECTOR TYPE	無鹵線 (HF) WIRE	顏色 COLOR	安規 SAFETY
<b>G2801DHF-180</b>	 WS-079-3 IEC 60320-2-2 SHEET C 2.5A 250V~	WS-027-5 IEC 60320-1 C7  H03Z1Z1H2-F 2X0.75mm <sup>2</sup>	 <b>B</b> BLACK	VDE By Request
<b>G2801EHF-180</b>		H05Z1Z1H2-F 2X0.75mm <sup>2</sup>		
<b>G2802DHF-180</b>		WS-027-8 IEC 60320-1 C7  H03Z1Z1H2-F 2X0.75mm <sup>2</sup>	 <b>B</b> BLACK	
<b>G2802EHF-180</b>		H05Z1Z1H2-F 2X0.75mm <sup>2</sup>		

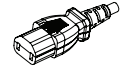
## G. 歐洲 EUROPE 3PIN



產品號 / 長度 / 公分 P/N / LENGTH / CM	插頭 / 連接器型式 PLUG / CONNECTOR TYPE	無鹵線 (HF) WIRE	顏色 COLOR	安規 SAFETY
<b>G1306FHF-180</b>	 WS-010A-1 3 PIN PLUG 16A 250V~	WS-083-A IEC 60320-1 C5  H03Z1Z1-F 3X0.75mm <sup>2</sup>	 <b>B</b> BLACK	VDE By Request
<b>G1306GHF-180</b>		H05Z1Z1-F 3X0.75mm <sup>2</sup>		
<b>G1304GHF-180</b>		WS-002A-3 IEC 60320-1 C13  10A 250V~ H05Z1Z1-F 3X0.75mm <sup>2</sup>	 <b>B</b> BLACK	
<b>G1305GHF-180</b>		WS-002A-R4 IEC 60320-1 C13 RIGHT ANGLE  10A 250V~ H05Z1Z1-F 3X0.75mm <sup>2</sup>	 <b>B</b> BLACK	
<b>G1311OHF-180</b>		WS-002E-3 IEC 60320-1 C17  10A 250V~ H05Z1Z1-F 2X0.75mm <sup>2</sup>	 <b>B</b> BLACK	



## G. 歐洲 EUROPE 3PIN



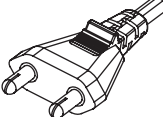
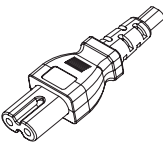

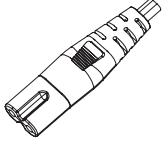
產品號 / 長度 / 公分 P/N / LENGTH / CM	插頭 / 連接器型式 PLUG / CONNECTOR TYPE	無鹵線 (HF) WIRE	顏色 COLOR	安規 SAFETY	
<b>G2706FHF-180</b>	WS-134-1 IEC 60320-2-2 SHEET A 	WS-083-A IEC 60320-1 C5 	H03Z1Z1-F 3X0.75mm <sup>2</sup>	 <b>B</b> BLACK	VDE By Request
<b>G2706GHF-180</b>	2.5A 250V~	2.5A 250V~ H05Z1Z1-F 3X0.75mm <sup>2</sup>			
<b>G2504GHF-180</b>	WS-003-4 IEC 60320-2-2 SHEET E 	WS-002A-3 IEC 60320-1 C13 	H05Z1Z1-F 3X0.75mm <sup>2</sup>	 <b>B</b> BLACK	

## I. 印度 INDIA 2PIN



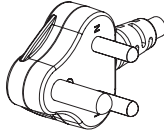
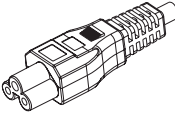

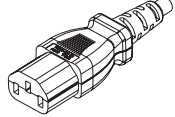
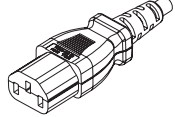
產品號 / 長度 / 公分 P/N / LENGTH / CM	插頭 / 連接器型式 PLUG / CONNECTOR TYPE	無鹵線 (HF) WIRE	顏色 COLOR	安規 SAFETY	
<b>I2101EHF-180</b>	WS-006F-1 2 PIN PLUG 	WS-027-5 IEC 60320-1 C7 	H05Z1Z1H2-F 2X0.75mm <sup>2</sup>	 <b>B</b> BLACK	BIS By Request
<b>I2102EHF-180</b>	2.5A 250V~	WS-027-8 IEC 60320-1 C7 	H05Z1Z1H2-F 2X0.75mm <sup>2</sup>		

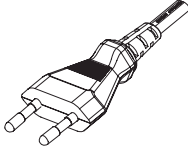
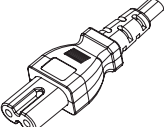

## I. 印度 INDIA 3PIN

產品號 / 長度 / 公分 P/N / LENGTH / CM	插頭 / 連接器型式 PLUG / CONNECTOR TYPE	無鹵線 (HF) WIRE	顏色 COLOR	安規 SAFETY
I2006GHF-180	WS-018-B 3 PIN PLUG 	WS-083-A IEC 60320-1 C5  2.5A 250V~	 BLACK	BIS By Request
I2004GHF-180	10A 250V~ 	WS-002A-3 IEC 60320-1 C13  10A 250V~	 BLACK	

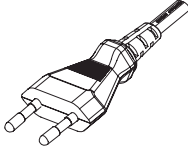
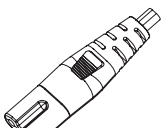



## L. 以色列 ISRAEL 2PIN

產品號 / 長度 / 公分 P/N / LENGTH / CM	插頭 / 連接器型式 PLUG / CONNECTOR TYPE	無鹵線 (HF) WIRE	顏色 COLOR	安規 SAFETY
L0701DHF-180	 WS-006-2 2 PIN PLUG	WS-027-5 IEC 60320-1 C7  2.5A 250V~	 BLACK	 SII
L0701EHF-180		H05Z1Z1H2-F 2X0.75mm <sup>2</sup>		
L0702DHF-180	 2.5A 250V~	WS-027-8 IEC 60320-1 C7  2.5A 250V~	 BLACK	
L0702EHF-180		H05Z1Z1H2-F 2X0.75mm <sup>2</sup>		



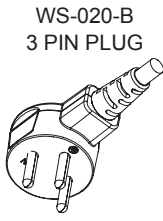
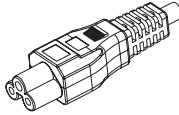

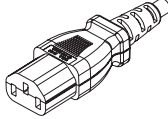

## L. 以色列 ISRAEL 3PIN

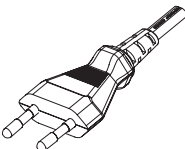
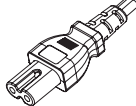
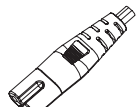

產品號 / 長度 / 公分 P/N / LENGTH / CM	插頭 / 連接器型式 PLUG / CONNECTOR TYPE	無鹵線 (HF) WIRE	顏色 COLOR	安規 SAFETY
L3406FHF-180	 WS-020-B 3 PIN PLUG  10A 250V~	WS-083-A IEC 60320-1 C5   H03Z1Z1-F 3X0.75mm <sup>2</sup>	 BLACK	 SII
L3406GHF-180		2.5A 250V~  H05Z1Z1-F 3X0.75mm <sup>2</sup>		
L3404GHF-180		WS-002A-3 IEC 60320-1 C13   10A 250V~  H05Z1Z1-F 3X0.75mm <sup>2</sup>	 BLACK	

## X. 義大利 ITALY 2PIN



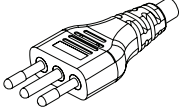
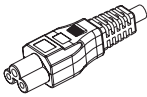

產品號 / 長度 / 公分 P/N / LENGTH / CM	插頭 / 連接器型式 PLUG / CONNECTOR TYPE	無鹵線 (HF) WIRE	顏色 COLOR	安規 SAFETY
X0701DHF-180	 WS-006-2 2 PIN PLUG  2.5A 250V~	WS-027-5 IEC 60320-1 C7   H03Z1Z1H2-F 2X0.75mm <sup>2</sup>	 BLACK	IMQ By Request
X0701EHF-180		2.5A 250V~  H05Z1Z1H2-F 2X0.75mm <sup>2</sup>		
X0702DHF-180		WS-027-8 IEC 60320-1 C7   2.5A 250V~  H03Z1Z1H2-F 2X0.75mm <sup>2</sup>	 BLACK	
X0702EHF-180		2.5A 250V~  H05Z1Z1H2-F 2X0.75mm <sup>2</sup>		

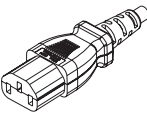

## X. 義大利 ITALY 3PIN

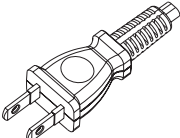
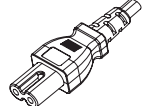

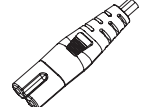



產品號 / 長度 / 公分 P/N / LENGTH / CM	插頭 / 連接器型式 PLUG / CONNECTOR TYPE	無鹵線 (HF) WIRE	顏色 COLOR	安規 SAFETY
<b>X1506FHF-180</b>	 WS-013-1 3 PIN PLUG  10A 250V~	WS-083-A IEC 60320-1 C5   2.5A 250V~	 <b>B</b> BLACK	IMQ By Request
<b>X1506GHF-180</b>		H03Z1Z1-F 3X0.75mm <sup>2</sup>		
<b>X1504GHF-180</b>		WS-002A-3 IEC 60320-1 C13   10A 250V~	H05Z1Z1-F 3X0.75mm <sup>2</sup>	

## J. 日本 JAPAN 2PIN

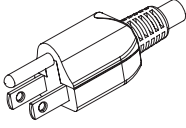
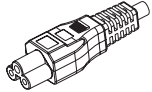
產品號 / 長度 / 公分 P/N / LENGTH / CM	插頭 / 連接器型式 PLUG / CONNECTOR TYPE	無鹵線 (HF) WIRE	顏色 COLOR	安規 SAFETY	
<b>J0601HHF-180</b>	 WS-005C-8 半绝缘 2 PIN PLUG  7A 125V~	WS-027-5 IEC 60320-1 C7   7A 125V~	 <b>B</b> BLACK		
<b>J0601JHF-180</b>		EM-OFF 2X0.75mm <sup>2</sup>			
<b>J0601KHF-180</b>		EM-OCTFK 2X0.75mm <sup>2</sup>			
<b>J0602HHF-180</b>		WS-027-8 IEC 60320-1 C7   7A 125V~	EM-OCTFK 2X0.75mm <sup>2</sup>		 <b>B</b> BLACK
<b>J0602JHF-180</b>		EM-OFF 2X0.75mm <sup>2</sup>			
<b>J0602KHF-180</b>		EM-ECTFK 2X0.75mm <sup>2</sup>			

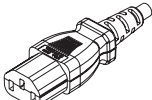
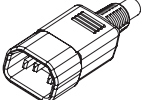
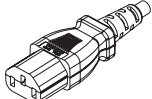

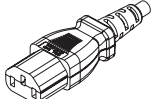
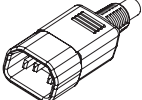
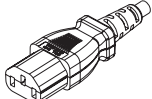
## J. 日本 JAPAN 3PIN



產品號 / 長度 / 公分 P/N / LENGTH / CM	插頭 / 連接器型式 PLUG / CONNECTOR TYPE	無鹵線 (HF) WIRE	顏色 COLOR	安規 SAFETY	
<b>J0106NHF-180</b>	WS-001-17 3 PIN PLUG 	WS-083-A IEC 60320-1 C5  7A 125V~	EM-ECTF 3X0.75mm <sup>2</sup>	 BLACK	
<b>J0106MHF-180</b>		WS-002A-3 IEC 60320-1 C13  7A 125V~	OOCTF/F 3X0.75mm <sup>2</sup>		
<b>J0104NHF-180</b>	WS-003-4 IEC 60320-2-2 SHEET E 	WS-002A-3 IEC 60320-1 C13  7A 125V~	EM-ECTF 3X0.75mm <sup>2</sup>	 BLACK	
<b>J0104MHF-180</b>		WS-002A-3 IEC 60320-1 C13  7A 125V~	OOCTF/F 3X0.75mm <sup>2</sup>		
<b>J2504NHF-180</b>	WS-003-4 IEC 60320-2-2 SHEET E 	WS-002A-3 IEC 60320-1 C13  7A 125V~	EM-ECTF 3X0.75mm <sup>2</sup>	 BLACK	

## K. 韓國 KOREA 3PIN



產品號 / 長度 / 公分 P/N / LENGTH / CM	插頭 / 連接器型式 PLUG / CONNECTOR TYPE	無鹵線 (HF) WIRE	顏色 COLOR	安規 SAFETY	
<b>K1306FHF-180</b>	WS-010A-1 3 PIN PLUG 	WS-083-A IEC 60320-1 C5  2.5A 250V~	H03Z1Z1-F 3X0.75mm <sup>2</sup>	 BLACK	KTC By Request
<b>K1306GHF-180</b>		WS-002A-3 IEC 60320-1 C13  10A 250V~	H05Z1Z1-F 3X0.75mm <sup>2</sup>		
<b>K1304GHF-180</b>		WS-002A-3 IEC 60320-1 C13  10A 250V~	H05Z1Z1-F 3X0.75mm <sup>2</sup>	 BLACK	

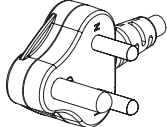
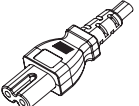

## S. 南非 SOUTH AFRICA 2PIN

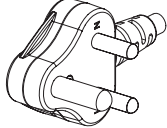
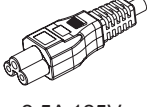

產品號 / 長度 / 公分 P/N / LENGTH / CM	插頭 / 連接器型式 PLUG / CONNECTOR TYPE	無鹵線 (HF) WIRE	顏色 COLOR	安規 SAFETY
<b>S2001DHF-180</b>	<p>WS-018-B</p>  <p>6A 250V~</p>	<p>WS-027-5 IEC 60320-1 C7</p>  <p>2.5A 125V~</p>	 <b>B</b> BLACK	SABS By Request
<b>S2001EHF-180</b>		<p>H03Z1Z1H2-F 2X0.75mm<sup>2</sup></p> <hr/> <p>H05Z1Z1H2-F 2X0.75mm<sup>2</sup></p>		

## S. 南非 SOUTH AFRICA 3PIN



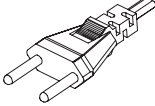
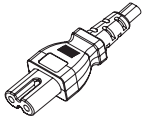

產品號 / 長度 / 公分 P/N / LENGTH / CM	插頭 / 連接器型式 PLUG / CONNECTOR TYPE	無鹵線 (HF) WIRE	顏色 COLOR	安規 SAFETY
<b>S2006FHF-180</b>	<p>WS-018-B 3 PIN PLUG</p>  <p>6A 250V~</p>	<p>WS-083-A IEC 60320-1 C5</p>  <p>2.5A 125V~</p>	 <b>B</b> BLACK	SABS By Request
<b>S2006GHF-180</b>		<p>H03Z1Z1-F 3X0.75mm<sup>2</sup></p> <hr/> <p>H05Z1Z1-F 3X0.75mm<sup>2</sup></p>		



## Z. 瑞士 SWITZERLAND 2PIN

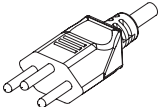
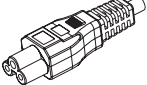

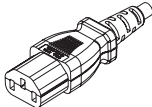

產品號 / 長度 / 公分 P/N / LENGTH / CM	插頭 / 連接器型式 PLUG / CONNECTOR TYPE	無鹵線 (HF) WIRE	顏色 COLOR	安規 SAFETY	
<b>Z7901DHF-180</b>	WS-014A 2 PIN PLUG  10A 250V~	WS-027-5 IEC 60320-1 C7  2.5A 250V~	H03Z1Z1H2-F 2X0.75mm <sup>2</sup>	 BLACK	SEV By Request
<b>Z7901EHF-180</b>		H05Z1Z1H2-F 2X0.75mm <sup>2</sup>	 BLACK		

## Z. 瑞士 SWITZERLAND 3PIN



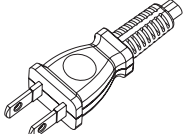
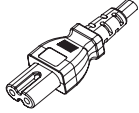

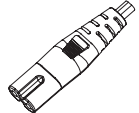
產品號 / 長度 / 公分 P/N / LENGTH / CM	插頭 / 連接器型式 PLUG / CONNECTOR TYPE	無鹵線 (HF) WIRE	顏色 COLOR	安規 SAFETY	
<b>Z1606FHF-180</b>	 WS-014-1 3 PIN PLUG 10A 250V~	WS-083-A IEC 60320-1 C5  2.5A 250V~	H03Z1Z1-F 3X0.75mm <sup>2</sup>	 BLACK	SEV By Request
<b>Z1606GHF-180</b>		H05Z1Z1-F 3X0.75mm <sup>2</sup>			
<b>Z1604GHF-180</b>		WS-002A-3 IEC 60320-1 C13  10A 250V~	H05Z1Z1-F 3X0.75mm <sup>2</sup>	 BLACK	



## T. 台灣 TAIWAN 2PIN

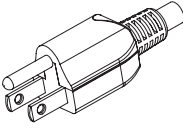
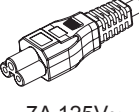

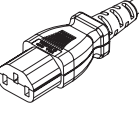





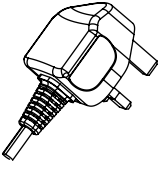
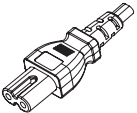

產品號 / 長度 / 公分 P/N / LENGTH / CM	插頭 / 連接器型式 PLUG / CONNECTOR TYPE	無鹵線 (HF) WIRE	顏色 COLOR	安規 SAFETY
T0601DHF-180	 WS-005C-8 2 PIN PLUG 7A 125V~	WS-027-5 IEC 60320-1 C7  H03Z1Z1H2-F 2X0.75mm <sup>2</sup>	 <b>B</b> BLACK	BSMI By Request
T0601EHF-180		H05Z1Z1H2-F 2X0.75mm <sup>2</sup>		
T0602DHF-180		WS-027-8 IEC 60320-1 C7  H03Z1Z1H2-F 2X0.75mm <sup>2</sup>	 <b>B</b> BLACK	
T0602EHF-180		H05Z1Z1H2-F 2X0.75mm <sup>2</sup>		

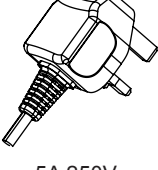
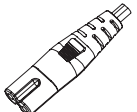
## T. 台灣 TAIWAN 3PIN

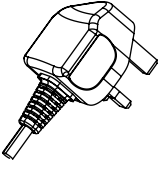
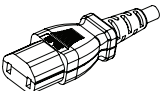
產品號 / 長度 / 公分 P/N / LENGTH / CM	插頭 / 連接器型式 PLUG / CONNECTOR TYPE	無鹵線 (HF) WIRE	顏色 COLOR	安規 SAFETY
T0106FHF-180	 WS-001-17 3 PIN PLUG 7A 125V~	WS-083-A IEC 60320-1 C5  H03Z1Z1-F 3X0.75mm <sup>2</sup>	 <b>B</b> BLACK	BSMI By Request
T0106GHF-180		H05Z1Z1-F 3X0.75mm <sup>2</sup>		
T0104GHF-180		WS-002A-3 IEC 60320-1 C13  H05Z1Z1-F 3X0.75mm <sup>2</sup>	 <b>B</b> BLACK	

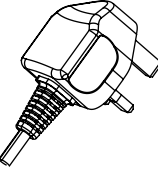
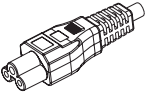

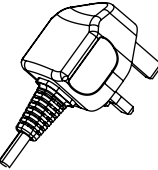
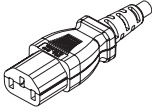





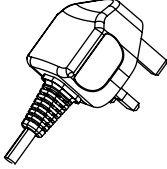
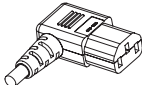

## U. 英國 UNITED KINGDOM 3PIN

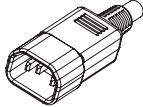
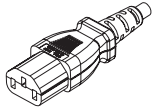
產品號 / 長度 / 公分 P/N / LENGTH / CM	插頭 / 連接器型式 PLUG / CONNECTOR TYPE	無鹵線 (HF) WIRE	顏色 COLOR	安規 SAFETY
<b>U1401DHF-180</b>	WS-012E 3 PIN PLUG 	WS-027-5 IEC 60320-1 C7 	H03Z1Z1H2-F 2X0.75mm <sup>2</sup>	 BLACK
<b>U1401EHF-180</b>	5A 250V~	2.5A 250V~	H05Z1Z1H2-F 2X0.75mm <sup>2</sup>	
<b>U1402DHF-180</b>	WS-012E 3 PIN PLUG 	WS-027-8 IEC 60320-1 C7 	H03Z1Z1H2-F 2X0.75mm <sup>2</sup>	 BLACK
<b>U1402EHF-180</b>	5A 250V~	2.5A 250V~	H05Z1Z1H2-F 2X0.75mm <sup>2</sup>	
<b>U1411OHF-180</b>	WS-012E 3 PIN PLUG 	WS-002E-3 IEC 60320-1 C17 	H05Z1Z1-F 2X0.75MM <sup>2</sup>	 BSI
<b>U1406FHF-180</b>	WS-012E 3 PIN PLUG 	WS-083-A IEC 60320-1 C5 	H03Z1Z1-F 3X0.75mm <sup>2</sup>	 BLACK
<b>U1406GHF-180</b>	5A 250V~	2.5A 250V~	H05Z1Z1-F 3X0.75mm <sup>2</sup>	
<b>U1404GHF-180</b>	WS-012E 3 PIN PLUG 	WS-002A-3 IEC 60320-1 C13 	H05Z1Z1-F 3X0.75mm <sup>2</sup>	 BLACK
	10A 250V~	10A 250V~		

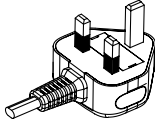
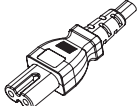

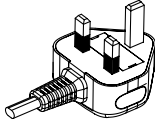
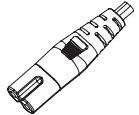





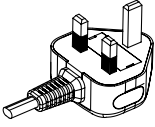
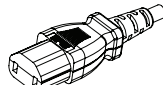

## U. 英國 UNITED KINGDOM 3PIN

產品號 / 長度 / 公分 P/N / LENGTH / CM	插頭 / 連接器型式 PLUG / CONNECTOR TYPE	無鹵線 (HF) WIRE	顏色 COLOR	安規 SAFETY
<b>U1405GHF-180</b>	WS-012E 3 PIN PLUG  10A 250V~	WS-002A-R4 IEC 60320-1 C13 RIGHT ANGLE  10A 250V~	H05Z1Z1-F 3X0.75mm <sup>2</sup>	 <b>B</b> BLACK
<b>U2504GHF-180</b>	WS-003-4 IEC 60320-2-2 SHEET E  10A 250V~	WS-002A-3 IEC 60320-1 C13  10A 250V~	H05Z1Z1-F 3X0.75mm <sup>2</sup>	 <b>B</b> BLACK
<b>U1201DHF-180</b>	WS-012E-1 3 PIN PLUG  5A 250V~	WS-027-5 IEC 60320-1 C7  2.5A 250V~	H03Z1Z1H2-F 2X0.75mm <sup>2</sup>	 <b>B</b> BLACK
<b>U1201EHF-180</b>		H05Z1Z1H2-F 2X0.75mm <sup>2</sup>		
<b>U1202DHF-180</b>	WS-012E-1 3 PIN PLUG  5A 250V~	WS-027-8 IEC 60320-1 C7  2.5A 250V~	H03Z1Z1H2-F 2X0.75mm <sup>2</sup>	 <b>B</b> BLACK
<b>U1202EHF-180</b>		H05Z1Z1H2-F 2X0.75mm <sup>2</sup>		

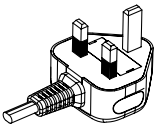
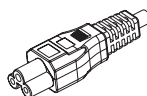

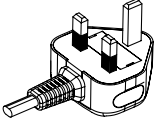
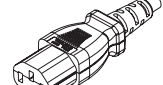

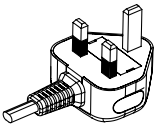
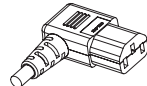
## U. 英國 UNITED KINGDOM 3PIN

產品號 / 長度 / 公分 P/N / LENGTH / CM	插頭 / 連接器型式 PLUG / CONNECTOR TYPE	無齒線 (HF) WIRE	顏色 COLOR	安規 SAFETY	
U1211OHF-180	WS-012E-1 3 PIN PLUG  10A 250V~	WS-002E-3 IEC 60320-1 C17  10A 250V~	H05Z1Z1-F 2X0.75MM <sup>2</sup>	 BLACK	BSI By Request
U1206FHF-180	WS-012E-1 3 PIN PLUG 	WS-083-A IEC 60320-1 C5  2.5A 250V~	H03Z1Z1-F 3X0.75mm <sup>2</sup>	 BLACK	
U1206GHF-180	5A 250V~	H05Z1Z1-F 3X0.75mm <sup>2</sup>			
U1204GHF-180	WS-012E-1 3 PIN PLUG  10A 250V~	WS-002A-3 IEC 60320-1 C13  10A 250V~	H05Z1Z1-F 3X0.75mm <sup>2</sup>	 BLACK	
U1205GHF-180	WS-012E-1 3 PIN PLUG  10A 250V~	WS-002A-R4 IEC 60320-1 C13 RIGHT ANGLE  10A 250V~	H05Z1Z1-F 3X0.75mm <sup>2</sup>	 BLACK	

產品號 P / N	圖號 P / N	產品號 P / N	圖號 P / N	產品號 P / N	圖號 P / N	產品號 P / N	圖號 P / N
(PVC) 美國 / 加拿大 AMERICA / CANADA		V291614-180	9993-0129	B540231-100	9993-0162	G280132-180	9993-0034
V050101-180	9993-0104	V050205-100	9993-0155	B540231-180	9993-0163	G280231-180	9993-0035
V050105-100	9993-0105	(PVC) 阿根廷 ARGENTINA		PVC 中國 CHINA		G280232-180	9993-0036
V050105-180	9993-0106	R110131-180	9993-0075	C030181-100	9993-0013	G130633-180	9993-0037
V050201-180	9993-0107	R110132-180	9993-0076	C030181-180	9993-0014	G130634-180	9993-0038
V050205-180	9993-0108	R020633-180	9993-0077	C030182-180	9993-0015	G130434-180	9993-0039
V050102-180	9993-0109	R020634-180	9993-0078	C030281-100	9993-0016	G130534-180	9993-0040
V050106-180	9993-0110	R020434-180	9993-0079	C030281-180	9993-0017	G131135-180	9993-0058
V050202-180	9993-0111	R110231-100	9993-0164	C030282-180	9993-0018	G270633-180	9993-0041
V050206-180	9993-0112	R110231-180	9993-0165	C320683-180	9993-0019	G270634-180	9993-0042
V280102-180	9993-0113	(PVC) 澳大利亞 AUSTRALIA		C320684-100	9993-0020	G250434-180	9993-0043
V280106-180	9993-0114	A100131-180	9993-0001	C320684-180	9993-0021	(PVC) 印度 INDIA	
V270610-180	9993-0115	A100132-180	9993-0002	C320484-100	9993-0022	I210171-180	9993-0045
V010610-100	9993-0116	A100231-180	9993-0003	C320484-180	9993-0023	I210271-180	9993-0047
V010610-180	9993-0117	A100232-180	9993-0004	(PVC) 丹麥 DENMARK		I200672-180	9993-0049
V010410-100	9993-0118	A170633-180	9993-0005	D610633-180	9993-0024	I200472-180	9993-0050
V010410-180	9993-0119	A170634-180	9993-0006	D610634-180	9993-0025	(PVC) 以色列 ISRAEL	
V010510-180	9993-0120	A170434-180	9993-0007	D610434-180	9993-0026	L070131-180	9993-0068
V010910-180	9993-0121	A100231-100	9993-0156	(PVC) 歐洲 EUROPE		L070132-180	9993-0069
V010912-180	9993-0122	G070231-100	9993-0157	G070131-180	9993-0027	L070231-180	9993-0070
V011914-180	9993-0123	(PVC) 巴西 BRAZIL		G070132-180	9993-0028	L070232-180	9993-0071
V250410-180	9993-0124	B540131-180	9993-0008	G070231-180	9993-0029	L340633-180	9993-0072
V291214-180	9993-0125	B540132-180	9993-0009	G070232-180	9993-0030	L340634-180	9993-0073
V291314-180	9993-0126	B550633-180	9993-0010	G330231-180	9993-0031	L340434-180	9993-0074
V291414-180	9993-0127	B550634-180	9993-0011	G330232-180	9993-0032	(PVC) 義大利 ITALY	
V291514-180	9993-0128	B550434-180	9993-0012	G280131-180	9993-0033	X070131-180	9993-0130

































產品號 P / N	圖號 P / N	產品號 P / N	圖號 P / N	產品號 P / N	圖號 P / N	產品號 P / N	圖號 P / N
X070132-180	9993-0131	S200633-180	9993-0082	U140634-100	9993-0098	V0104AHF-180	9993-2091
X070231-180	9993-0132	S200634-180	9993-0083	U140634-180	9993-0099	V0105AHF-180	9993-2092
X070232-180	9993-0133	(PVC) 瑞士 SWITZERLAND		U140434-100	9993-0100	V2504AHF-180	9993-2093
X150633-180	9993-0134	Z790131-180	9993-0137	U140434-180	9993-0101	(HF) 阿根廷 ARGENTINA	
X150634-180	9993-0135	Z790132-180	9993-0138	U140534-180	9993-0102	R1101DHF-180	9993-2059
X150434-180	9993-0136	Z160633-180	9993-0139	U250434-180	9993-0103	R1101EHF-180	9993-2060
(PVC) 日本 JAPAN		Z160634-180	9993-0140	U120131-100	9993-0142	R0206FHF-180	9993-2061
J060151-180	9993-0051	Z160434-180	9993-0141	U120131-180	9993-0143	R0206GHF-180	9993-2062
J060152-180	9993-0052	Z790231-100	9993-0160	U120132-180	9993-0144	R0204GHF-180	9993-2063
J060153-180	9993-0053	Z790231-180	9993-0161	U120231-180	9993-0145	(HF) 澳大利亞 AUSTRALIA	
J060251-180	9993-0054	(PVC) 台灣 TAIWAN		U120232-180	9993-0146	A1001DHF-180	9993-2001
J060252-180	9993-0055	T060153-100	9993-0084	U121135-180	9993-0147	A1001EHF-180	9993-2002
J060253-180	9993-0056	T060153-180	9993-0085	U120633-180	9993-0148	A1002DHF-180	9993-2003
J061753-180	9993-0057	T060253-100	9993-0086	U120634-100	9993-0149	A1002EHF-180	9993-2004
J010655-100	9993-0060	T060253-180	9993-0087	U120634-180	9993-0150	A1706FHF-180	9993-2005
J010655-180	9993-0061	T010655-100	9993-0088	U120434-100	9993-0151	A1706GHF-180	9993-2006
J010455-180	9993-0062	T010655-180	9993-0089	U120434-180	9993-0152	A1704GHF-180	9993-2007
J010458-180	9993-0063	T010455-180	9993-0090	U120534-180	9993-0153	(HF) 巴西 BRAZIL	
J250455-180	9993-0064	(PVC) 英國 UNITED KINGDOM		U120231-100	9993-0154	B5401DHF-180	9993-2008
(PVC) 韓國 KOREA		U140131-100	9993-0091	(HF) 美國 / 加拿大 AMERICA / CANADA		B5401EHF-180	9993-2009
K130633-180	9993-0065	U140131-180	9993-0092	V0501BHF-180	9993-2085	B5506FHF-180	9993-2010
K130634-180	9993-0066	U140132-180	9993-0093	V0501CHF-180	9993-2086	B5506GHF-180	9993-2011
K130434-180	9993-0067	U140231-180	9993-0094	V0502BHF-180	9993-2087	B5504GHF-180	9993-2012
(PVC) 南非 SOUTH AFRICA		U140232-180	9993-0095	V0502CHF-180	9993-2088	(HF) 丹麥 DENMARK	
S200131-180	9993-0080	U141135-180	9993-0096	V2706AHF-180	9993-2089	D6106FHF-180	9993-2013
S200132-180	9993-0081	U140633-180	9993-0097	V0106AHF-180	9993-2090		

# 圖號對照表































產品號 P / N	圖號 P / N	產品號 P / N	圖號 P / N	產品號 P / N	圖號 P / N	產品號 P / N	圖號 P / N
D6106GHF-180	9993-2014	I2004GHF-180	9993-2037	J0106MHF-180	9993-2045	T0106GHF-180	9993-2073
D6104GHF-180	9993-2015	(HF) 以色列 ISRAEL		J0104NHF-180	9993-2046	T0104GHF-180	9993-2074
(HF) 歐洲 EUROPE		L0701DHF-180	9993-2052	J0104MHF-180	9993-2047	(HF) 英國 UNITED KINGDOM	
G0701DHF-180	9993-2016	L0701EHF-180	9993-2053	J2504NHF-180	9993-2048	U1401DHF-180	9993-2075
G0701EHF-180	9993-2017	L0702DHF-180	9993-2054	(HF) 韓國 KOREA		U1401EHF-180	9993-2076
G0702DHF-180	9993-2018	L0702EHF-180	9993-2055	K1306FHF-180	9993-2049	U1402DHF-180	9993-2077
G0702EHF-180	9993-2019	L3406FHF-180	9993-2056	K1306GHF-180	9993-2050	U1402EHF-180	9993-2078
G3302DHF-180	9993-2020	L3406GHF-180	9993-2057	K1304GHF-180	9993-2051	U1411OHF-180	9993-2079
G3302EHF-180	9993-2021	L3404GHF-180	9993-2058	(HF) 南非 SOUTH AFRICA		U1406FHF-180	9993-2080
G2801DHF-180	9993-2022	(HF) 義大利 ITALY		S2001DHF-180	9993-2064	U1406GHF-180	9993-2081
G2801EHF-180	9993-2023	X0701DHF-180	9993-2094	S2001EHF-180	9993-2065	U1404GHF-180	9993-2082
G2802DHF-180	9993-2024	X0701EHF-180	9993-2095	S2006FHF-180	9993-2066	U1405GHF-180	9993-2083
G2802EHF-180	9993-2025	X0702DHF-180	9993-2096	S2006GHF-180	9993-2067	U2504GHF-180	9993-2084
G1306FHF-180	9993-2026	X0702EHF-180	9993-2097	(HF) 瑞士 SWITZERLAND		U1201DHF-180	9993-2106
G1306GHF-180	9993-2027	X1506FHF-180	9993-2098	Z7901DHF-180	9993-2101	U1201EHF-180	9993-2107
G1304GHF-180	9993-2028	X1506GHF-180	9993-2099	Z7901EHF-180	9993-2102	U1202DHF-180	9993-2108
G1305GHF-180	9993-2029	X1504GHF-180	9993-2100	Z1606FHF-180	9993-2103	U1202EHF-180	9993-2109
G1311OHF-180	9993-2030	(HF) 日本 JAPAN		Z1606GHF-180	9993-2104	U1211OHF-180	9993-2110
G2706FHF-180	9993-2031	J0601HHF-180	9993-2038	Z1604GHF-180	9993-2105	U1206FHF-180	9993-2111
G2706GHF-180	9993-2032	J0601JHF-180	9993-2039	(HF) 台灣 TAIWAN		U1206GHF-180	9993-2112
G2504GHF-180	9993-2033	J0601KHF-180	9993-2040	T0601DHF-180	9993-2068	U1204GHF-180	9993-2113
(HF) 印度 INDIA		J0602HHF-180	9993-2041	T0601EHF-180	9993-2069	U1205GHF-180	9993-2114
I2101EHF-180	9993-2034	J0602JHF-180	9993-2042	T0602DHF-180	9993-2070		
I2102EHF-180	9993-2035	J0602KHF-180	9993-2043	T0602EHF-180	9993-2071		
I2006GHF-180	9993-2036	J0106NHF-180	9993-2044	T0106FHF-180	9993-2072		

## IEC 60320-1 & 60320-2 International Standard

Appliance couplers for household and similar general purposes-Interconnection couplers for household and similar equipment.

IEC 60320-1 Appliance Couplers			IEC 60320-2-2 Interconnection Coupler		
Connectors		Inlets	Plug Connectors	Outlets	
 <b>C1</b>	Class II Cold	 <b>C2</b>		0.2A Household	These couplers are not in the IEC 60320 standard.
 <b>C5</b>	Class I Cold	 <b>C6</b>	 <b>SHEET A</b>	Class I	 <b>SHEET B</b>
 <b>C7</b>	Class II Cold	 <b>C8</b>	 <b>SHEET C</b>	Class II	 <b>SHEET D</b>
 <b>C9</b>	Class II Cold	 <b>C10</b>		6A Household	These couplers are not in the IEC 60320 standard.
 <b>C13</b>	Class I Cold	 <b>C14</b>	 <b>SHEET E</b>	Class I	 <b>SHEET F</b>
 <b>C15</b>	Class I Hot	 <b>C16</b>		10A International/ 15A North American Household	These couplers are not in the IEC 60320 standard.
 <b>C15A</b>	Class I Very Hot	 <b>C16A</b>			These couplers are not in the IEC 60320 standard.
 <b>C17</b>	Class II Cold	 <b>C18</b>	 <b>SHEET G</b>		Class II
 <b>C19</b>	Class I Cold	 <b>C20</b>	 <b>SHEET I</b>	Class I	 <b>SHEET J</b>
 <b>C21</b>	Class I Very Hot	 <b>C22</b>		16A International/ 20A North American Household	These couplers are not in the IEC 60320 standard.
 <b>C23</b>	Class II Cold	 <b>C24</b>	 <b>SHEET K</b>		Class II

*We gained Safety Standard approval of different country*

 UL	 C-UL	 UL&C-UL	 UL	 C-UL	 UL&C-UL	
 Brazil	 Mexico	 Argentina	 Argentina	 Australia	 South Africa	
 European	 Germany	 Germany	 DEMKO Denmark	 United Kingdom	 United Kingdom	
 IMQ Italy	 SEV Switzerland	 FIMKO Finland	 NEMKO Norway	 SEMKO Sweden	 Korea	
 China 3C	 Taiwan CNS	 India	 Japan	 Singapore	 Russia	 Israel



  
**ISO 9001:2008**  
**REGISTERED**

  
**UKAS**  
**QUALITY MANAGEMENT**  
003

  
**ISO 14001:2004**  
**REGISTERED**

  
**UKAS**  
**ENVIRONMENTAL MANAGEMENT**  
003

Quality Manufacturer and Green Partner  
 Awarded Sony Green Partner Certification in 2005.



**WELL SHIN TECHNOLOGY CO., LTD.**

[www.wellshin.com.tw](http://www.wellshin.com.tw)

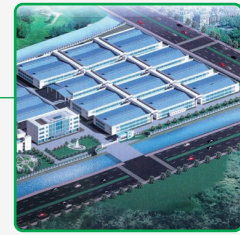

### **Kun Shan Plant**

維爾斯電子(昆山)有限公司

Well Shin Electronic (Kun Shan) Co., Ltd.

江蘇省昆山市錦溪鎮昆開路389號

No.389, Kun Kai Rd., Jin Xi Town, Kun Shan City,  
Jiang Su 215324, China

Tel : 86-512-5722-9101 Fax : 86-512-5722-9105



### **Headquarter Taipei**

維熹科技股份有限公司

Well Shin Technology Co., Ltd.

114臺北市內湖區新湖三路196號

No.196, Xinghu 3rd Rd., Neihu District,  
Taipei City 114, Taiwan

Tel : 886-2-2791-1119 Fax : 886-2-2791-9901



### **Kentucky Plant**

美國肯塔基廠

Factory : Kentucky, USA

1801 Trane Way Louisville, KY 40299, USA

Tel : 1-414-482-0800 Fax : 1-414-482-0220



### **Dongguan Plant**

東莞維升電子製品有限公司

Dongguan Well Shin Electronic Products Co., Ltd.

廣東省東莞市黃江鎮長龍管理區

Chang Long Control Dist., Hwang Jiang Cheng,  
Dongguan City, Guandong 523766, China

Tel : 86-769-8362-2694 Fax : 86-769-8362-2714



### **Taiwan Plant**

台灣工廠

Taiwan Plant

彰化縣福興鄉麥厝村沿海路一段1號

No.1, Sec. 1, Yanhai Rd., Fuxing Township,  
Changhua County 506, Taiwan

Tel : 886-4-770-3081 Fax : 886-4-770-3080